

HOME-BUILT MECHANICAL RECEIVERS

Television

and *SHORT-WAVE WORLD*

DECEMBER 1938

No. 130. Vol. XI.

1/-

**SIMPLE
RECEIVER
FOR
TELEVISION
SOUND**

**SUPER-
SONIC
LIGHT
VALVE
INCREASING
RANGE**

**SHORT
WAVES**

**FAULTS
AND THEIR
REMEDIES**

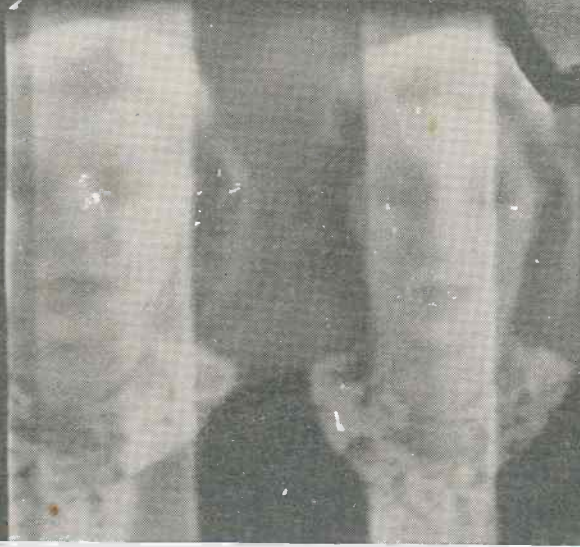

**EXPLAINED
PICTORIALLY**

**MAKING A CHEAP ROTARY-BEAM ANTENNA
AN A.C. MAINS S.W. RECEIVER
USING THE 801 VALVE**

BERNARD JONES PUBLICATIONS LTD.
CHANSITOR HOUSE, CHANCERY LANE
LONDON W.C.2.

THE FIRST TELEVISION JOURNAL IN THE WORLD

TELEVISION

and SHORT-WAVE WORLD

Special Features

	PAGE
Home Construction of Mechanical Receivers	716
Television Picture Faults	717
The Photo-electric Cell in Practical Use	721
The Scophony Home Receiver	724
4-valve Superhet for Television Sound	726
Supersonic Light Valve Simply Explained	734
How the Picture is Synchronised	741
Increasing Range	744
2-XP Gramophone Amplifier	747
Johnson "Q" Matching System	750
3-valve Receiver for A.C. Mains	754
6L6G-801 Transmitter	756
Experimental 5-metre Transmitter	764
Rotary Beam Antenna	770

COMMENT OF THE MONTH

O.B. Successes

THE much increased number of outside broadcasts of the past month have had the effect of greatly accelerating receiver sales. We have definite proof of this in the large number of inquiries which we have had respecting receivers and the references made to these special programmes. We have repeatedly stressed the desirability of this type of transmission and we congratulate the Alexandra Palace staff on the resource it has shown in allowing no topical event of any importance to escape the television camera. They have included the Lord Mayor's Show, the Cenotaph Ceremony, the arrival of King Carol, Ice Hockey, Boxing and lastly transmissions from the actual stages of two London theatres.

In our opinion, the importance of these last two transmissions cannot be overstressed for they open up wonderful possibilities. For the first attempts of this nature it was inevitable that a certain amount of inconvenience would be caused to the theatre management, and possibly the audience, but this is a trouble that will soon be overcome. Obviously, there is now no reason whatever why the B.B.C. Variety broadcasts from St. George's Hall should not be a regular feature of the television programmes and we suggest this as the next move.

There is a suggestion that we should like to make with regard to these outside broadcasts. This is that on every occasion there should be a few minutes' studio transmission both at the beginning and end of each outside broadcast. The reason is that on these occasions the transmissions are seen by large numbers of people who are new to television and as, owing to unsuitable or difficult conditions, quality may suffer, such people get a wrong idea of the quality possible. A direct studio transmission with an announcement of the quality of picture that should have been receivable (observed on a check receiver at Alexandra Palace) would correct this, and, in the case of definitely bad transmissions, which in some circumstances are unavoidable, remove doubt from viewers' minds that their receivers were faulty.

C.W.R.

OVER 800 active members have now been accepted out of the large number of amateurs who applied for enrolment in the recently formed Civil Wireless Reserve. The scope of this Reserve has now been increased by the formation of two Experimental Sections for those who wish to undertake technical work rather than to do Morse operating. The first of the Experimental Sections was formed to consider Air Ministry work only, while the second section will handle problems which may arise during the running of the C.W.R.

In the first group most of the members are qualified radio engineers and so far radio amateurs with specialised knowledge are being included in the second Experimental Section. We consider that this Reserve presents an excellent opportunity to amateurs who wish to extend their radio knowledge which will be of use to them in peace time, and enable them to be of service to their country in time of emergency.

TELEVISION AND SHORT-WAVE WORLD

Proprietors:
BERNARD JONES PUBLICATIONS, LTD.

Editor-in-Chief:
BERNARD E. JONES.

Editor:
H. CORBISHLEY, F.T.S.

Short-Wave Editor: KENNETH JOWERS

Editorial, Advertising and Publishing Offices:

Chansitor House, 38, Chancery Lane, London, W.C.2.

Telephones: Holborn 6158, 6159.

Telegrams: Beejapee, Holb., London.

Subscription Rates: Post paid to any part of the world—3 months, 3/6; 6 months, 7/-; 12 months, 14/-.

Published Monthly—1/- net.
(On the first day of the month).

Contributions are invited and will be promptly considered. Correspondence should be addressed according to its nature, to the Editor, the Advertisement Manager, or the Publisher, "Television and Short-wave World," Chansitor House, Chancery Lane, London, W.C.2.

IMPORTANT

"Television and Short-wave World" is registered at the General Post Office, London, for transmission to Canada and Newfoundland by Magazine Post. Entered as Second-class mail matter, Boston, Mass.

HOME CONSTRUCTION OF MECHANICAL RECEIVERS

RECEPTION OF A.P. TRANSMISSIONS ACHIEVED WITH SIMPLE APPARATUS

IN recent articles the problems were discussed which confront the amateur who desires to receive the present transmissions by optical-mechanical scanning methods, and some arrangements were suggested that it was thought would make this possible with simple apparatus. These were suggestions for experiment based on sound theoretical considerations.

Further experiments with these arrangements have shown that they do receive the television programmes according to prediction, both as regards size of picture received and degree of definition. These it will be remembered were not ambitious, but nevertheless they are sufficient for interesting results. Moreover, owing to the possibility of relying on the time-controlled 50-cycle mains for synchronisation, which has proved, up to a point, to be practicable, and owing also to the reduced frequency response of the receiver necessary, it has been possible to get pictures even in a rather poor location, with a receiver using a total of only six ordinary type valves (excluding power packs).

This, in all probability, represents the simplest way in which it is possible to receive pictures on the present transmissions.

At the moment our experiments have not yet reached the point where really satisfactory reception can be

guaranteed, but they are being continued and it is hoped that very soon we shall be able to present to our readers the design of a very simple and cheap receiver.

We may recapitulate the description given in earlier articles, as follows:—There is a light source consisting of a small filament lamp of the "exciter" or motor headlamp type, overrun above its normal voltage, from a transformer or accumulator. The light is modulated by a supersonic relay (quartz crystal and liquid) and passes to a simple line scanner. The simple cylindrical lenses and a second (frame) scanner made from plate glass suffice to project a picture on to a ground glass screen. Both scanners can be driven from the controlled 50-cycle mains by suitable synchronous motors.

Suitable scanners and motors are commercially available, and were kindly provided for our experiments by H. E. Sanders & Co., whose assistance we acknowledge.

Synchronising

Our experiments have shown that ordinary transmissions (i.e., not outside broadcasts, which are sometimes not tied to the mains) give pictures which for the greater part of the time remain fairly steady, without other than mains control. As a final standard of reception such a state of affairs could not, of course, be toler-

ated, and therefore development of a suitable unit, for providing the necessary extra control of scanner speed from the received signals is proceeding.

Radio Arrangements

The light relay has to be operated by a modulated oscillator, which can employ either suppressor grid or plate type of modulation. With the latter, a positive signal is required. The present arrangement is not required to deal with a wide frequency band and a receiver can therefore be built simply and cheaply.

We have, therefore, evolved a simple type of vision receiver comprising one R.F. stage, reactive detector and two V.F. stages, followed by modulator and oscillator valves, which suffices for distances of 30 miles or so from Alexandra Palace. Where strong signals are received, the H.F. stage could be dispensed with, or alternatively, instead of plate modulation in two V.F. stages it would be possible to use suppressor grid (type) modulation with only one V.F. stage.

Assuming that our further experiments are successful, as we have every reason to believe they will be, we hope to present to our readers a complete simple and cheap design of receiver employing mechanical-optical methods.

Television Festival Dinner

The Duke of Kent presided at the first television dinner at the Dorchester Hotel on November 3 in support of the appeal for the new premises fund of the Royal Photographic Society. About 550 guests, watching forty televisions, saw and heard Beverley Nichols replying from Alexandra Palace to the toast of "The Guests," proposed by the Rt. Hon. Leslie Burgin, the Minister of Transport. Afterwards, a special programme, which included Gracie Fields, Oliver Wakefield, Jean Colin and Douglas Byng, was transmitted

from Alexandra Palace, and excellent reception was obtained at the Dorchester. Special aerial arrangements were installed for the occasion, which comprised a tilted wire anti-interference aerial on the roof of the Dorchester with a feeder to an aerial amplifier. The output from this amplifier to the various receivers was then taken by co-axial feeder.

Twelve makes of receiver were used, these being Ferranti, H.M.V., Marconiphone, Pye, G.E.C., R.G.D., Burndept, Cossor, Ultra, Murphy, Baird and Invicta. Receiver position was balloted for and pride of place was secured by Ferranti's.

Burndept Reunion Dinner

Plans have been made to have a Reunion Dinner of the old officials and employees of the original Burndept and subsidiary companies which were formed before 1928. This dinner is to be held on Friday, January 20, 1939, and the Reunion Secretary, Mr. W. H. Higgs, of 73 Madeira Avenue, Bromley, is desirous of getting into touch with any old members of the works or office staffs (either male or female) of the Burndept companies who up to the present have not been acquainted with the arrangements made for this reunion.

TELEVISION PICTURE FAULTS AND THEIR REMEDIES—I

By S. West

This short series of articles will deal with some of the more generally experienced television picture faults. The treatment is rather unusual inasmuch as photographs have been secured of actual images wherein a fault or faults is depicted. The cause for each of these is dealt with and then the procedure necessary to adopt in order to clear the fault is outlined. The survey of faults will be most comprehensive and the series of articles should be of great value to owners of either commercial or home-constructed receivers.

IT is a fact that any person whose knowledge of television receiver design is at all complete can, in the majority of cases, by examining a defective image, at once state the probable cause and the necessary cure for the defect, or briefly, he can with expedition place the apparatus in good order.

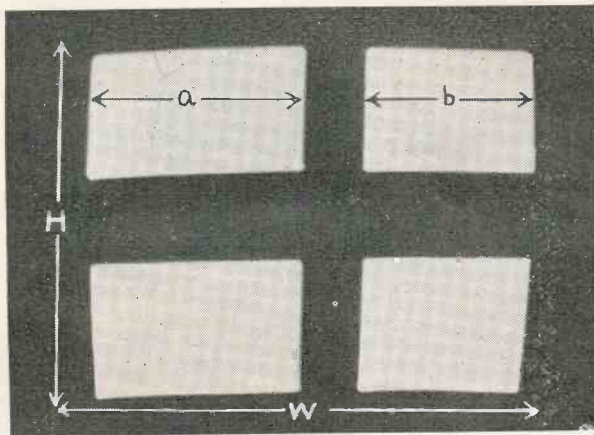

Fig. 1. Appearance of cruciform pattern due to non-linear line sweep voltage.

It is the writer's opinion that for the less knowledgeable person it is only necessary to show him pictures of faulty images, mutually agree which of these is truly representative of the fault experienced, then to detail the circuit changes necessary to effect a cure, and he is almost as well equipped as the more experienced worker to correct television image faults. The photographs to be reproduced in this series of articles were therefore obtained for this purpose.

It should perhaps be added that such photographs are not by any means easy to make. In the first place they were all secured in the writer's laboratory about 100 miles from the transmitter, which fact alone rendered the task intricate. Secondly, it is one of the anomalies of such apparatus that a specific fault that can occur entirely unintentionally, and when it is not wanted, often is difficult to invoke to order; moreover certain minor faults cannot be photographed at all. Despite these difficulties, it is believed the complete series will be representative.

Raster Faults

If we adopt a logical order of faults we find that we are firstly concerned with the plain raster, for obviously

we must have this right before tackling the remedy of actual picture reproduction defects.

The most commonly experienced fault in a raster is that due to non-linear scan in either the vertical or horizontal direction or both concurrently.

Figs. 1, 3 and 5 depict the familiar cruciform pattern radiated by the transmitter prior to the commencement of the programme. Let us consider the image of Fig. 1. It is seen that the distance a is greater than b . This is due to the production of a non-linear sweep voltage by the line time base. The desired wave form for the oscillation is shown in Fig. 2a. The wave-form responsible for the non-linearity is likely to have a form resembling that shown in Fig. 2b.

Now it is important fully to appreciate the following.

The saw-tooth oscillation is produced by the charge, through a resistance, and the discharge, through an electronic device (i.e., a gas relay), of a condenser. The charge current is of the form indicated by the curve AB in Figs. 2a and 2b. This curve has an exponential shape but it is seen that if we arrange the discharge to take place at x , Fig. 2a, that this portion of the curve is reasonably linear. Consequently for a linear scan, we must arrange for the discharge cycle to occur at this point or earlier. It should be mentioned parenthetically there is an alternative, namely, to employ a constant current device (pentode or diode valve) through which the condenser is charged. It is not proposed to deal with such arrangements, however, for they render the apparatus more complex. To achieve this end, that is to ensure linearity of charge, the time base H.T. must be high (usually over 1,200 volts for a 12 in. tube), for it is obvious we only employ a very small part of the complete charge curve.

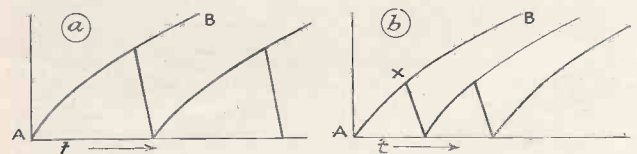

Figs. 2a and 2b. Correct and incorrect time base wave forms.

Assuming the H.T. is adequate, then the point x , in the case of a time base employing gas relays, is chosen by the value of bias for this valve and will have adequate amplitude for our needs. Precisely similar procedure is involved for other forms of time base, the main point being that the condenser must discharge at x or earlier.

PICTURE RATIO FAULTS

Time Base Speed

This brings us to another consideration, namely, the nearer to A that our discharge takes place, the higher will be the frequency of the saw-tooth oscillations. Obviously this is so for the discharge takes place earlier on the curve AB, which is plotted against time. So that, if in our efforts to ensure linearity, we have caused our time base to operate at an incorrect frequency we must remedy the matter.

This is simply achieved. It is assumed that the capacity of the charge condenser has the conventional value for the position in which it is used and it only requires to increase the value of the charge resistance to reduce the frequency of the oscillations.

Condensing the above information for a specific case, that of a time base employing a gas-relay saw-tooth oscillation generator, if non-linearity of scan exists, reduce the bias of the relay by reducing in value the cathode resistance, or make similar changes to whatever biasing arrangement is employed, then, restore to the correct operating frequency by increasing the value of the charge resistance.

Picture Ratio

In Fig. 3 we have the cruciform pattern once more. Note that the line sweep is again non-linear but a more unpleasant effect obtrudes, namely, the aspect ratio is entirely incorrect, the ratio of height to width being disproportionate.

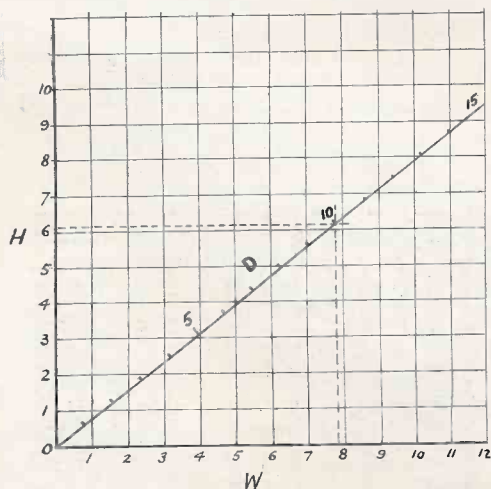

Fig. 4. Height-width picture dimensions.

The correct aspect ratio for pictures transmitted from Alexandra Palace is 5:4. From Fig. 4 the correct picture dimensions can be obtained. The diameter of the tube is given by the diagonal D. Knowing this the correct height and width is easily secured.

For example, the W/H ratio for a tube having a 10 in. diameter screen is seen to be $7\frac{3}{4}$ in. by $6\frac{1}{4}$ in. In practice it is permissible to exceed these dimensions but the proportions must be retained.

Now within the limitations imposed by the requirements for linearity of scan, we can adjust this aspect ratio with the bias on the discharge valve and this is the correct course to adopt.

It is necessary to interpose a word here concerning time bases that employ a balanced output system (electrostatic deflection). Whilst the picture shape can be controlled to a certain extent by varying the input to

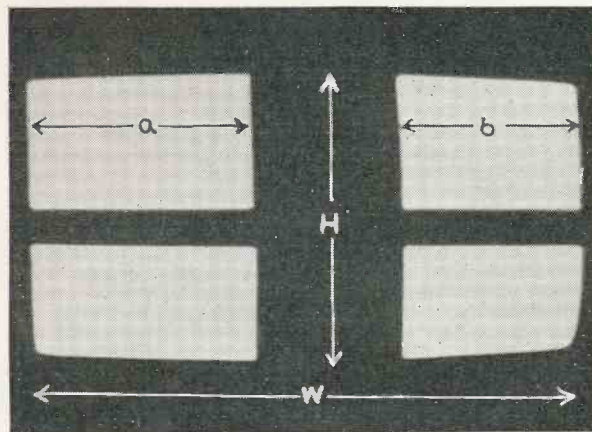

Fig. 3. Another effect of non-linear line sweep voltage producing incorrect aspect ratio.

the second amplifying stage, such procedure is unwise. This point will be dealt with later in some detail but for the time being it can be assumed that with the paraphase valve removed, the picture should be approximately half the width or height, as the case may be. It is seen then that the correct aspect ratio is mainly determined, once the amplifying stages are designed, by the amplitude of the oscillation generated by the gas relay.

Fig. 5 is again of the cruciform pattern. For all practical purposes the aspect ratio and linearity can be deemed satisfactory. There is shown slight non-linearity in both the frame and line bases but for various reasons it is difficult entirely to remove this defect.

An examination of this photograph reveals the distance a to be slightly greater than a_1 (slight non-linearity in the line base). Similarly b is greater than b_1 (slight non-linearity in the frame base). The aspect ratio R , that is H/W , is substantially correct. Note also the good contrast, namely, black and white and not an indeterminate contrast.

Figs. 6 and 7 show the effect of applying an oscillatory voltage to either the C.R. tube or the V.F. valve grid. If no oscillator is available it is worth while setting up temporary gear for this test.

A frequency of approximately 400-1,000 cycles per second is entirely satisfactory for the vertical test and approximately 150-200 kilocycles per second for the horizontal. A simple dynatron oscillator serves admirably. Alternatively most service oscillators will readily furnish these frequencies. As a matter of interest the writer used the scan voltage of a high-frequency oscilloscope.

LINEARITY

This test pattern is of particular value for determining the linearity or otherwise of the scan when no transmission is available. One point requires observing otherwise the tests are completely valueless. The time bases must be operating at substantially the correct speeds for there is little object in achieving linearity at entirely incorrect operating frequencies.

The simplest way of ensuring this is to adjust the time bases accurately to the correct frequency during a transmission. Greater accuracy is ensured by making

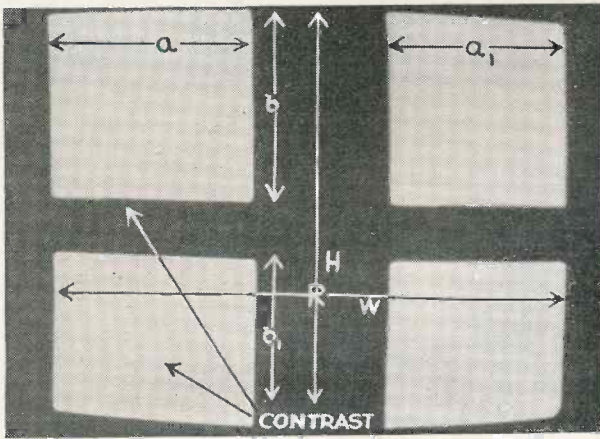

Fig. 5. Cruciform pattern with slight non-linearity in both line and frame sweep voltages.

the sync. pulses amplitude very small, then, by applying signals in the manner indicated, the number of bars and the frequency to produce these can be noted, and these settings repeated at any time. Of course, if the frequency of the modulating voltage is fairly accurately known it is a simple matter to calculate the number of bars that should be produced when the time base frequencies are correct, and this is an alternative adoptable scheme.

Linearity

Now to ensure linearity, adjustments are made until the spacing of the bars is even over the whole screen. The photograph, Fig. 6, shows the test pattern for linearity in the vertical (frame) time base and is secured by feeding a low-frequency signal to the modulating electrode. Actually slight non-linearity is indicated, but is not serious. Fig. 7 shows the same scheme employed for checking linearity in the horizontal sense (line). Even spacing of the bars should be striven for.

Finally, Fig. 8 shows the unpleasant effect secured with a non-linear frame (vertical) scan. The distances a and a_1 should be equal. It is seen that the picture is badly distorted, the servant girl's face dominating the picture whilst the other character's features are compressed. The rounded corners of the picture are due, of course, to the cathode-ray tube bulb curvature. The corners of the raster should not be permitted to wander much over the screen's periphery for apart from the loss of picture subject, particularly in captions, this rounded edge distortion becomes objectionable.

Before we leave this question of non-linearity of

sweep voltage it is as well to mention that included in this category are the following faults:

Overload of the scan voltage amplifiers. As the types of valve normally specified for such positions can

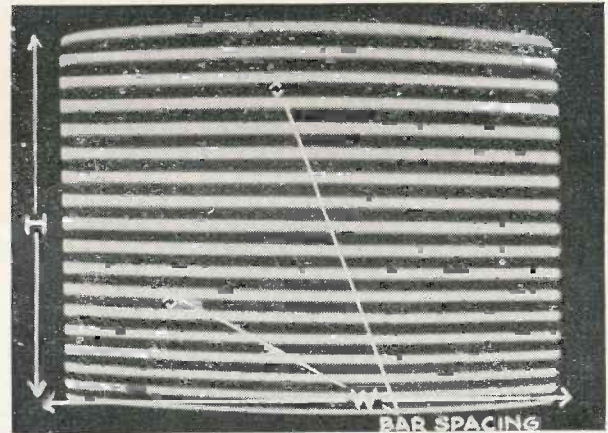

Fig. 6. Test pattern for linearity of frame time base.

handle easily the grid signals involved it is not proposed to deal with the question in any detail.

The question of balance in a push-pull deflector plate feed system has also been remarked. If the balance is not reasonably good an asymmetrical scan will result. This effect is a form of non-linearity, though in the writer's experience other defects thus caused are more deleterious. It has already been pointed out that the balance should be such that each valve contributes approximately one half the scan. If this requirement is observed then no trouble from this source will be experienced. The condition is satisfied by making the paraphase tap at $1/Mth.$ of the anode resistance. M is the magnification of the stage.

These conditions are usually catered for as is also that of freedom from amplitude, phase and frequency distortion for the amplifiers design. From a designer's

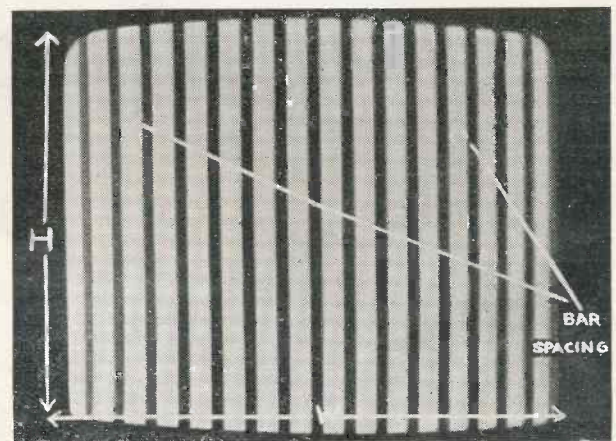

Fig. 7. Test pattern for linearity of line time base.

viewpoint they are important however and should receive due attention.

Incidentally the frequencies involved can be deemed

to be of the order of 20 times the fundamental operation frequency of this time base.

A study of all these photographs will reveal one fundamental fact. Any non-linearity of the scan voltage developed by the saw-tooth oscillator is revealed as a compression of the right-hand or the bottom picture edge.

No attempt to cure picture distortion occurring as a compression of the left-hand picture edge should be made in the manner outlined above. This defect will be dealt with later. It is due either to non-linearity of the flyback, though this is rare, or to the line retrace occurring with insufficient rapidity. Actually the first effect is often a corollary of the second and in any case is not important unless the interval occupied is greater than a certain percentage of the line time.

In the next article of this series trapezium distortion and also actual picture defects will be dealt with.

(To be continued)



Fig. 8. Effect due to non-linear frame scan.

Baird Cinema Television

The Baird Company gave further demonstrations of their big-screen cathode-ray projection system at the Tatler Theatre on the occasions of the Lord Mayor's Show and Cenotaph Ceremony. Since the Derby and Trooping the Colour demonstrations were given, new equipment has been installed which includes a special tube with a screen measuring 5 in. by 4 in. instead of 4 in. by 3 in. as formerly. Good as were the results obtained at the time of the Derby, they were surpassed at this latest demonstration—in fact they were amazing. Later comparison with small screen pictures proved that such defects as there were were due to the transmissions, and that results on the large screen were the equal of those obtainable on home receivers. Both definition and brilliancy were exceedingly good and a few minutes of the studio transmission showed that they were almost up to cinema standard. The Baird Company are to be congratulated on this remarkable development work.

Book Review

Testing Television Sets, by J. H. Reyner, B.Sc., A.M.I.E.E. (Chapman and Hall, Ltd.). This book is primarily intended for the wireless service man who in the near future will be called upon to test and repair television receivers in addition to broadcast receivers. The author has therefore assumed that the reader has a general knowledge of television receiver principles and the entire book is devoted to an analysis of receiver faults, their location and remedy.

So far as has been possible, treatment has been sectionised and faults due to tube, time base, synchronising, receiver and interference are dealt with separately. Additional chapters deal with test apparatus and laboratory technique. Much of the information is of a general character which will be helpful to the non-professional reader, and the serviceman will undoubtedly find the book a very valuable help. It is well illustrated by photographs showing the appearance of faults on the screen and with many diagrams. The price is 9s. 6d.

Cathode-ray Tube Holders

Constructors and experimenters who are using the small cathode-ray tubes fitted with an 8-pin octal base, find that the ordinary octal valve holder is not completely satisfactory owing to the high voltage connections being exposed.

We were very glad to see that Messrs. A. F. Bulgin & Co., Ltd., of Abbey Road, Barking, Essex, have produced a special base for this type of cathode-ray tube. The base is a modification of the octal but is completely shrouded so that the high-voltage connections cannot be accidentally touched. The base of the holder is also covered, with a single hole left through which the connections can be taken.

Supplies of these tube holders are now available at 1s. 3d. each, the type number being VH58. For the convenience of readers in London, deliveries can be obtained from 64 Holborn Viaduct, E.C.1.

A New Q.C.C. Crystal Holder

Amongst the large number of components that have been introduced this season by the Quartz Crystal Company, Ltd., of Kingston Road, New Malden, Surrey, is a new type of enclosed holder, designated type U, which is for use with the S5, P5 and Q5 frequency-control units. It is of modern design and appearance as can be seen from the illustration. This holder, made of a Keramot body, ground stainless steel electrodes, resilient contact pins, with a $\frac{3}{4}$ in. spacing so that it is suitable for use with standard American 5-pin valve



The new Q.C.C. crystal holder fits American type valve holders.

holders. It is $1\frac{1}{2}$ in. in diameter and $\frac{1}{2}$ in. deep. This holder is priced at 6s. fitted with a plate which is stamped with the frequency of the crystal.

An entirely new crystal of the low temperature co-efficient type is also available for 27s. 6d. This is the Q5 unit with a temperature co-efficient of less than 4 cycles per mc. per degree centigrade change. Maximum R.F. crystal current 150 mA.

We advise all readers to get in touch with the Quartz Crystal Company for full information not only on their new crystals but on new components in general.

THE PHOTO-ELECTRIC CELL IN PRACTICAL USE

A SERIES OF CIRCUITS SHOWING LIGHT CELL APPLICATIONS

This comprehensive series of photo-cell circuits has been collected from various sources and we acknowledge particular indebtedness to "Electronics."

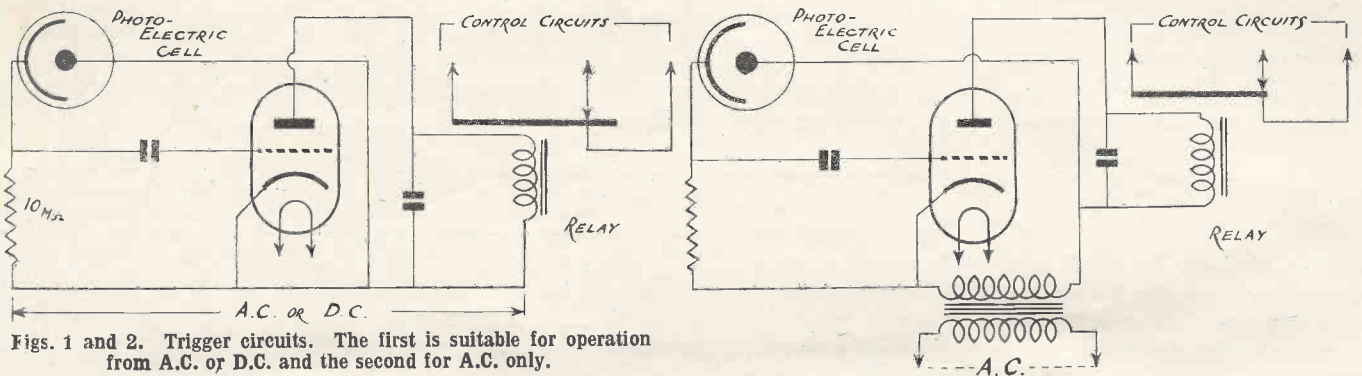

Figs. 1 and 2. Trigger circuits. The first is suitable for operation from A.C. or D.C. and the second for A.C. only.

TWO trigger arrangements are shown by the drawings above, Figs. 1 and 2. Fig. 1 is suitable for operation on either A.C. or D.C. Fig. 2 is for A.C. operation only. No grid leak is provided, and there is no necessity for maintaining any particular potential on

the grid) the grid assumes its own negative potential. This circuit is probably the most sensitive combination possible for any three-electrode valve. If used on A.C. a condenser must be shunted across the relay to prevent chatter, but if used on D.C. this is unnecessary.

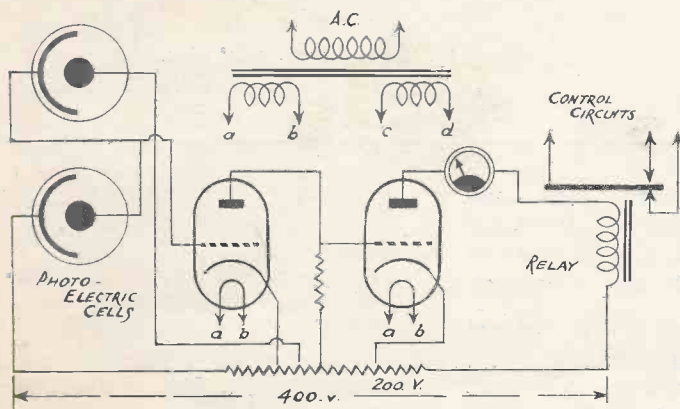

Fig. 3. Two stages direct coupled.

When two or more stages are used there are three types of coupling which can be employed, namely, resistance coupling, transformer coupling and direct coupling. Fig. 3. (above) shows an example of direct coupling. It will be noted that the plate of the first valve is connected directly to the grid of the second, therefore, the potential of the plate will maintain the potential at the grid of the second valve at the same value. The various voltages employed are taken

from the voltage divider shown. The proper voltage conditions on the elements of both valves must be maintained.

Supposing that the plate of the first valve receives its potential from the mid-point of the divider, which is 200 volts; resistor R, then serves as the plate load and its value should be about 50,000 ohms. The potential of the plate will then be approximately 100 volts (100 volt drop in potential existing across the resistor R). The grid of the second valve also has a potential of 100 volts. The grid bias of the first valve is taken directly from the voltage divider. The characteristic of the first valve should be such that the cathode should be approximately 15 volts positive with respect to the grid. Since the grid of the second valve is at 100 volts potential, the cathode is then connected to the voltage divider at approximately 115 volts, which will be on the positive side of the plate tap for the first valve as shown.

Very minute changes in the light intensity falling on either of the cells shown, will result in large changes in the anode current of the second valve. As far as the action is concerned, the output of the second valve will be exactly the same as the output of a one-valve amplifier, except that it will have this added sensitivity.

If applied to a colour matching device, this arrangement is capable of detecting differences in colour or in light intensity, which are far beyond detection by the human eye. It is important that a separate voltage supply be provided for the two filaments, otherwise a leakage will occur between cathode and filament which can cause breakdown in the tube.

Active American U.H.F. Stations

This list indicates some of the American U.H.F. stations which are now active. Many of these should be heard in Europe if a good receiver and aerial system are used. The stations are of three types, general broadcast, general police and relay.

Call.	Location.	Frequency.
W2XSN	P. F. Godley, Montclair, N.J.	41.8mc.

Relay Broadcast

W4XGO	Isle of Dreams, Miami, Fla.	Gen. Re.
W5XHU	WDSU, Inc., Ardmore, Okla.	Gen. Re.
W8XO	Carter Pub., Ft. Worth, Tex.	Gen. Re.
W8XRZ	WJR, Inc., Detroit, Mich.	Gen. Re.
W9XMK	Peoria Brdcstg., Peoria, Ill.	Gen. Re.
W10XIO & W10XIQ	Yankee Network, Boston, Mass.	Gen. Re.

Forestry Service

W1XOA to W1XQF	Mass, Dept. of Conservation	Gen. Br.
W3XMP	Maryland Dept., Brandywine	Gen. Br.
W3XMQ	Maryland Dept.	Gen. Br.

Police Broadcast

W1XLI	Boston, Mass.	Gen. Po.
W2XSI & W2XSJ	New York City Police Dept.	33.1mc.
W2XSK	Rockland County, N.Y.	Gen. Po.
W2XOZ	Lakewood, N.J.	Gen. Po.
W2XPS	Lakewood, N.J.	Gen. Po.
W2XOG	Hempstead, N.Y.	40.1mc.
W2XQH, I, J, K, L, M	Hempstead, N.Y.	40.1mc.
W2XRX	Hempstead, N.Y.	Gen. Po.
W2XSL	New York City Police Dept.	Gen. Po.
W2XSM	Englewood, N.J.	Gen. Po.
W2XSO	White Plains, N.Y.	Gen. Po.
W2XSP to W2XSS	White Plains, N.Y.	Gen. Po.
W2XSY	Elwood, N.J.	Gen. Po.
W3XLJ to W3XLN	Wilmington, Del.	Gen. Po.
W3XMC	Bound Brook, N.J.	33.1, 37.1mc.
W3XMD	Bound Brook, N.J.	33.1, 37.1mc.
W3XML	Staunton, Va.	Gen. Po.
W3XMM to W3XMO	Camden, N.J.	Gen. Po.
W4XGD	Sanford, Fla.	Gen. Po.
W4XGG & W4XGH	Wilmington, N.C.	33.1mc.
W4XGP to W4XGT	Tampa, Fla.	30.1mc.
W4XGU & W4XGV	Miami, Fla.	30.1, 33.1mc.
W5XEL, M, N, O, P	Wichita Falls, Tex.	Gen. Po.
W5XFA to W5XFT	Austin, Texas	Gen. Po.
W6XUA	Las Vegas, Nev.	30.1mc.
W6XUP	National City, Cal.	Gen. Po.
W6XUQ & W6XUR	Alameda County, Cal.	37.1mc.
W6XUX & W6XUY	Long Beach, Cal.	Gen. Po.
W6XXA to W6XXL	Los Angeles, Cal. County	Gen. Po.
W6XXZ	Watsonville, Cal.	Gen. Po.
W6XYF & W6XYG	Los Angeles, Cal. Red Cross	
W7XDU & W7ZDX	Portland, Ore	Gen. Po.
W7XDW & W7XDX	Multnomah County, Ore.	30.1mc.
W7XDY	Pierce County, Ore.	33.1, 37.1mc.
W7XEG to W7XEJ	Butte, Mont.	40.1mc.
W8XPS	Wayne Count., Mich.	33.1mc.
W8XQX	Royal Oak, Mich.	30.1mc.
W8XRC	Oneonta, N.Y.	30.1mc.
W8XRE	Ottawa Hills, Ohio	Gen. Po.
W8XRF	Ottawa Hills, Ohio	Gen. Po.
W8XRR	Midland, Mich.	Gen. Po.
W8XRS	Wierton, West Va.	33.1mc.
W8XRT to W8XRW	Wierton, West Va.	33.1mc.
W8XRX & W8XRY	Fremont, Ohio	30.1mc.
W8XSD	Indian Hill, Ohio	33.1, 37.1mc.
W8XSE & W8XSF	Indian Hill, Ohio	33.1, 37.1mc.

"An Experimental 5 metre Transmitter"

(Continued from page 766)

merely for stand-by operation. It enables the H.T. voltage to be switched off with the valves still supplied with L.T. voltage.

By using the Eddystone rack recommended, this little transmitter can be used in a standard relay rack. There is also sufficient space on the chassis to take a small unit so experimenters who wish to use this transmitter fairly permanently could mount everything on the one chassis. It is not intended for long-distance communication for it is not suitable for reception with anything but flatly tuned receivers of the super-regenerative type, but it is quite suitable for local working and field days should a small convertor be obtainable.

Components for AN EXPERIMENTAL TRANSMITTER

- CHASSIS AND PANEL.**
1—Chassis type 1109 (Eddystone).
2—Brackets type 1110 (Eddystone).
1—Panel type 1112 NO4 (Eddystone).
- CONDENSERS, FIXED.**
1—.002-mfd. type 620 (Cr) (Dubilier).
1—.50-mfd. 50 v. type 3004 (C2) (Dubilier).
1—.1-mfd. type 4603/S (C3) (Dubilier).
1—.01-mfd. type 691W (C4) (Dubilier).
1—.01-mfd. type 691W (C5) (Dubilier).
1—.10-mfd. 50 v. type 3016 (C6) (Dubilier).
1—.10-mfd. 50 v. type 3016 (C7) (Dubilier).
1—.4-mfd. 500 v. type 0281 (C8) (Dubilier).
- CONDENSERS, VARIABLE.**
1—.00015-mfd. type VC15X (VCr) (Raymatt).
- DIALS.**
1—Type 1098 (Eddystone).
1—I.P.7. (Bulgin).
- HOLDED, VALVE.**
1—4-pin type SW21 (Bulgin).
2—8-pin octal type 1120 (Eddystone).
- JACK.**
1—Type closed-circuit insulated (Premier Supply Stores).
- PLUG.**
1—Type P15 (Bulgin).
- MICROPHONE.**
1—Reisz type (Premier Supply Stores).
- RESISTANCES, FIXED.**
1—10,000 ohm type 2-watt (R1) (Erie).
1—30 ohm CT (R2) (Premier Supply Stores).
1—500,000 ohm type 1/2-watt (R3) (Dubilier).
1—200 ohm type 4-watt (R4) (Premier Supply Stores).
1—15,000 ohm type 1-watt (R5) (Erie).
1—15,000 ohm type 8-watt (R6) (Premier Supply Stores).
1—20,000 ohm type 8-watt (R7) (Premier Supply Stores).
1—5,000 ohm type 8-watt (R8) (Premier Supply Stores).
1—2,000 ohm type 1-watt (R9) (Premier Supply Stores).
1—60,000 ohm type 1-watt (R10) (Premier Supply Stores).
1—50,000 ohm type 1-watt (R11) (Premier Supply Stores).
- RESISTANCE, VARIABLE.**
1—500,000 potentiometer type B (VR1) (Dubilier).
- TRANSFORMERS.**
1—Microphone type LF35 (T1) (Bulgin).
1—Output type I-1 ratio (T2) (Ferranti).
- VALVES.**
1—TZ08-20 (Mullard).
1—6L6G (V2) (Tungsram).
1—6C5G (V3) (Tungsram).
- POWER UNIT SECTION**
- CHASSIS.**
1—Steel chassis 10 x 8 x 1 1/2 ins. (Premier Supply Stores).
- CONDENSERS, FIXED.**
1—4-mfd. type LEG 600 v. (Cr) (Dubilier).
1—4-mfd. type LEG 600 v. (C2) (Dubilier).
- CHOKE, L.F.**
1—200 m AH10/250 (L. F. Cr) (Sound Sales).
- SWITCH.**
1—Toggle type S80T (Bulgin).
- TRANSFORMER.**
1—to give 1—500-0-500 120 m A.
2.5-0-2.5 3 A.
3.75-0-3.75 2 A.
3.15-0-3.15 1.5 A.
(T1) (Premier Supply Stores).
- VALVE.**
1—5Z3 (Premier Supply Stores).

INTERIOR (BACK) VIEW OF SCOPHONY MECHANICAL-OPTICAL HOME RECEIVER SHOWING ARRANGEMENT OF UNITS

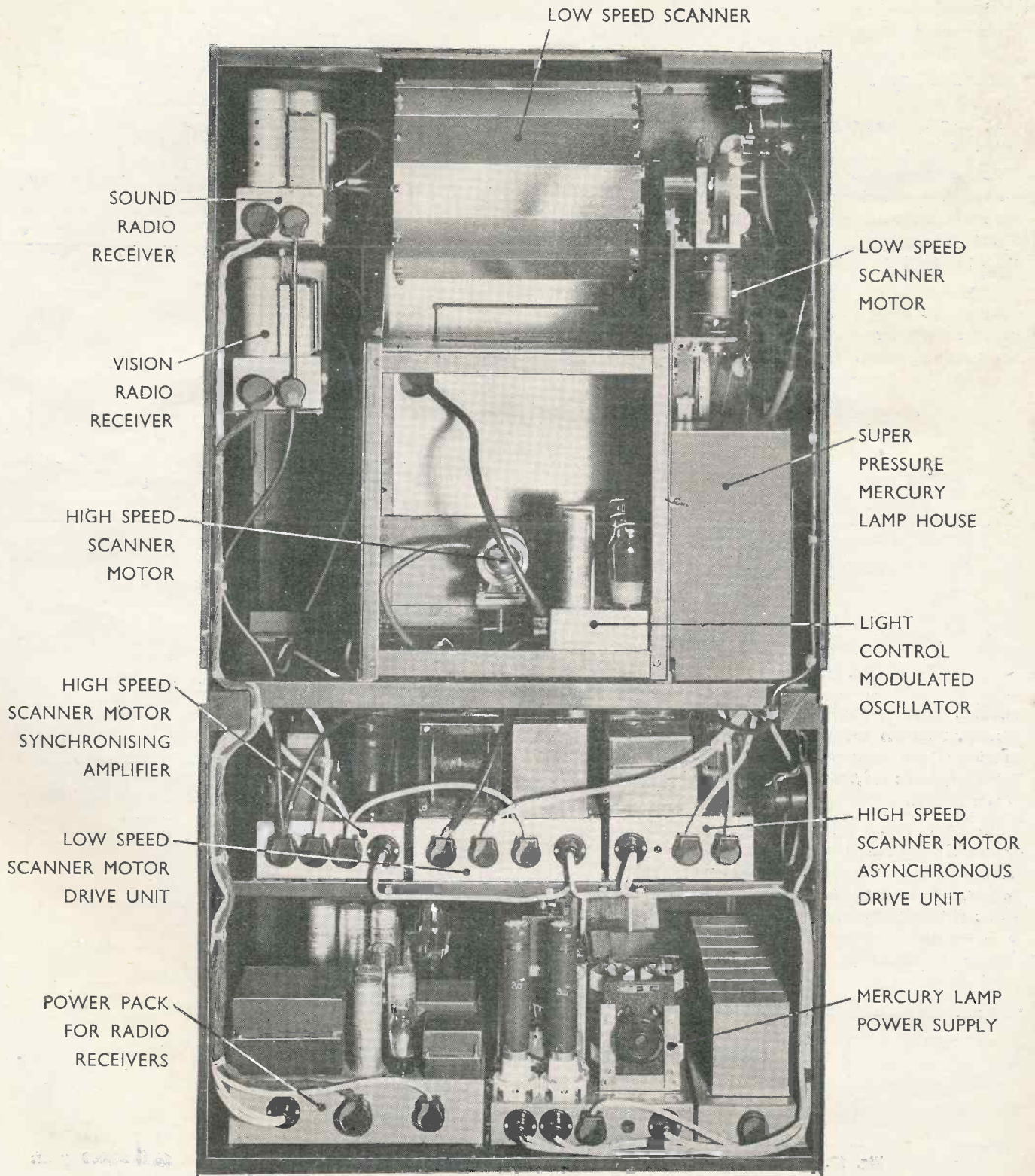

THE SCOPHONY HOME RECEIVER

AN OUTLINE OF ITS CONSTRUCTION

ON the opposite page we show a photograph of the interior of the Scophony home receiver which, of course, is a mechanical-optical type. This receiver provides a picture size 24 in. by 22 in. and the following are the brief particulars.

Radio Apparatus

For the reception of the two transmissions on the ultra-short waves from Alexandra Palace, two separate receivers are used.

For the sound, six valves are employed, utilising tuned radio-frequency amplification at carrier frequency. Anode-bend rectification is employed and is fed to two output valves which work the 10-in. loud-speaker.

Tuned radio frequency amplification is also used to receive the vision signals. Eight valves are employed of which four are R.F. amplifiers and two are diodes for rectification and synchronising separation.

Light-control Modulator

The output from the radio receiver is via a low-impedance output valve and co-axial cable to the modulated oscillator driving the light control. The quartz crystal in the light control has a high fundamental frequency and the driving unit consists of video amplifier, oscillator R.F. amplifier, and D.C. reinsertion valve.

The R.F. amplifier valve is connected to the quartz crystal on the light control and is grid modulated by the video amplifier.

High-speed Scanner

A high-speed motor rotates a small mirror polygon which produces the line scanning of the picture. It runs at a synchronous speed of 30,375 r.p.m. The motor itself consists of two separate sections built in one case. One section is an asynchronous motor to bring the motor quickly up to the required speed, and the other a synchronous motor to which are fed the synchronising signals suitably amplified from the vision radio receiver.

Low-speed Scanner

A low speed scanner produces the frame scan of the picture. There are twelve mirrors on the scanner and this is driven by a synchronous motor running at 1,500 r.p.m. through a reduction gear to a final speed of 250 r.p.m. The power to drive the motor is obtained by amplifying the frame synchronising pulse obtained from the vision radio receiver.

Light Modulator

The light control consists of a container, filled with a liquid, at one end of which is a quartz crystal. When the quartz is actuated by a modulated carrier frequency, the fundamental frequency of which is the same as that of the quartz, supersonic waves are set up at a speed corresponding to the velocity of the sound waves in

that particular liquid. The container has on either side of it a lens, and when light is passed through the container and focused on to a scanner and from the scanner on to a screen with suitable lenses, an image of the light control itself can be formed on the screen, the width being the width of one line of the picture and the length is determined by the length of the light control liquid column. When modulation is applied to the quartz crystal nothing will be seen on the screen until the scanner which is between the screen and the light control is rotated at such a speed that it follows the speed of the ultra sonic waves in the liquid exactly. The modulation then becomes visible on the screen. A large number of scanning spots can thus be used simultaneously.

Light Source

The light source is a super high-pressure mercury lamp which is operated from a D.C. source of 80 volts with a consumption of $3\frac{1}{2}$ amperes; the total power consumption is approximately 300 watts. The brilliancy of this light source is more than treble that of a carbon arc using the same power.

The mercury lamp is focused on to the light control, from the light control to the high speed scanner (a stainless steel polygon) and from there on to the low speed scanner which gives the picture repetition frequency, and finally through a projection lens on to the 2 ft. screen.

Book Review

Principles of Electricity and Magnetism, by Gaylord P. Harnwell (The McGraw Hill Book Co., Aldwych House, London, W.C.). From the title of this book it might be assumed that it is a text-book on magnetism and electricity of the type with which everyone is familiar. It is a text-book, but it differs so widely from forerunners that its title does not in any way convey an idea of its scope. Whilst it is theoretical, it is also experimental and the subjects with which it deals are presented in a manner which has not been attempted

before. The book provides a link between theory of the past and modern theory and practice. A brief résumé of the main subjects will indicate the scope of the work and these are as follows:—Electrostatics, Electrostatic Energy and Dielectrics, Physical Characteristics of Dielectrics and Conductors, Direct-Current Circuits, Nonohmic Circuit Elements and Alternating Currents, Chemical, Thermal and Photoelectric Effects, Thermionic Vacuum Tubes, Electrical Conduction in Gases, Electromagnetic effects of steady currents, changing electric currents and electromagnetic Reactions, Magnetic Pro-

perties of Matter, Electromagnetic Machinery, Simple Circuits Containing Inductance, Capacitance and Resistance, Coupled Circuits, Filters and Lines, Vacuum Tube Circuits, Radiation, and they are all dealt with in the light of present-day knowledge.

The book will be found invaluable to the student who desires to obtain a knowledge of the whole conception of modern electrical development irrespective of any particular branch of the science. In all there are over 600 pages and the price is 30s. It is a book that can be highly recommended to the serious student.

BAIRD RECEIVERS SET A PERFORMANCE STANDARD BY WHICH OTHERS ARE JUDGED

Model T.18 is a complete Television Receiver combined with a very selective and high quality All-wave Radio, yet the compact cabinet housing the complete equipment is little larger than the usual Table Radio. The most recent developments in Television design are included, yet the price is below that of many modern Radio-gramophones. The set is easy to operate—and without any technical knowledge you can be confident of good results.

TELEVISION CONTROLS : These have been reduced to one which operates the Picture Contrast, and this will only need very occasional adjustment.

TELEVISION SOUND AND RADIO : The sound receiver is a super-heterodyne covering the Television sound waveband, and three bands for Radio programmes (Short : 16.5—51 metres ; Medium : 198—550 metres ; and Long : 850—2,000 metres). It is possible to receive the sound on the Television waveband either with or without the Picture by means of a switch integral with the Picture Contrast control. For Radio, stations are calibrated by name, and each waveband is individually illuminated. The reproduction is exceptionally fine since the set is capable of delivering an 8 watt quality output.

PICTURE SIZE : 10 in. wide by 8 in. high. Viewed direct.

POWER CONSUMPTION : 150 watts.

CABINET : The cabinet measures approximately 25 in. high, 18 in. wide and 16 in. from back to front. It is attractively designed as illustrated and is standard in walnut.

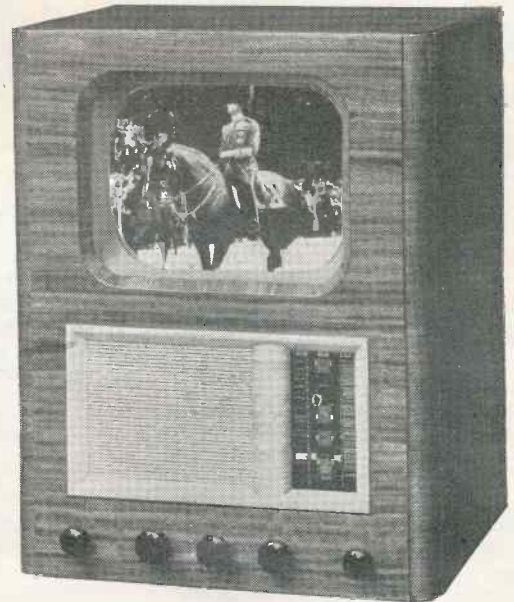

PRICE 44 GNS.

DEMONSTRATIONS ARRANGED

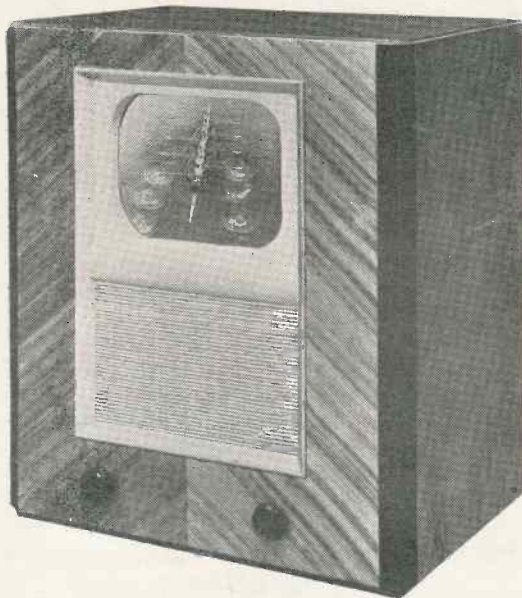

PRICE 35 GNS.

Model T.20 proves that Television for home installation need be neither a complicated nor a costly business, for here is a complete receiver no larger than a Radio set, yet capable of giving an excellent picture with all that wealth of detail for which Baird receivers are known, together with quality sound reproduction. Controls have been reduced to a minimum and no skilled technical knowledge is needed to operate the set and get the best out of it.

The very attractive price should make this model the means of bringing Television into many homes where the interest of this most modern source of entertainment has as yet not been enjoyed.

CONTROLS : The T.20 has two main controls on the front of the cabinet. Picture Contrast and Sound Volume.

POWER CONSUMPTION : 150 watts.

SOUND : A superhet radio receiver is fitted and this is pre-set to receive Television sound.

PICTURE SIZE : 7½ in. wide by 6½ in. high. Viewed direct.

CABINET : The Walnut Cabinet measures approximately 22 in. high, 18 in. wide and 13 in. from back to front. It is beautifully made and well finished.

Send for full descriptive literature. Post Free.

BAIRD TELEVISION LTD.

Lower Sydenham, London, S.E.26

Telephone: HITHER GREEN 4600.

Telegrams: TELEVISOR, FOREST, LONDON.

G.E.C.

NEW CATHODE RAY MONITOR TUBE

TYPE 4053
(1½ in. screen)

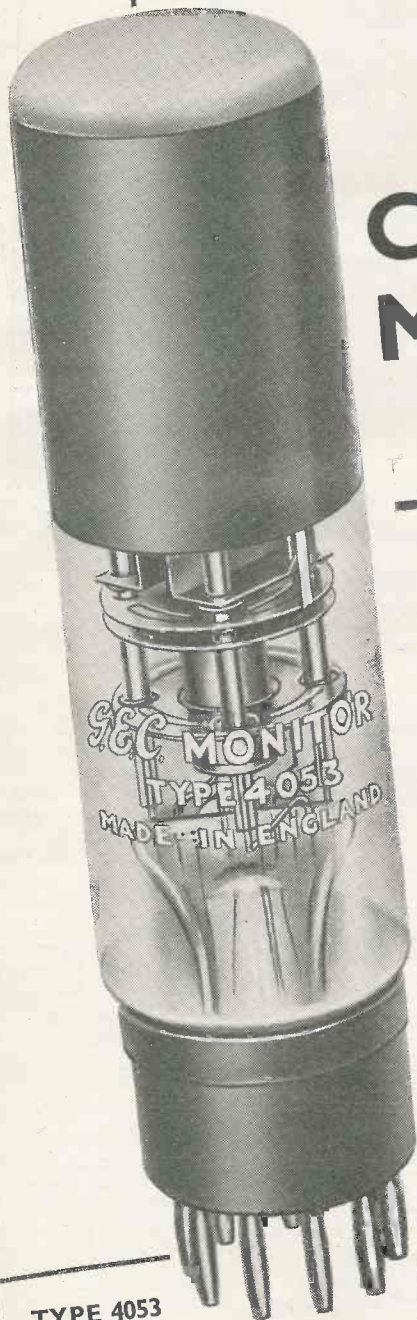

TYPE 4053

Overall length 160 m/m
Dia. of bulb 40 m/m

LIST
PRICE

45/-

(fitted with British 9-pin base)

New and improved—both in sensitivity and focus

A new 1½ inch high vacuum Cathode-Ray Tube, type 4053, is now available which replaces type 4051 at the same price. The G.E.C. Type 4053 carries all the advantages possessed by Type 4051:—

Small size for portability and compactness:

Low operating voltages.

Separate connections to each of the four deflector plates.

Separate modulating electrode.

High vacuum.

In addition, the deflection sensitivity is increased to 120/V m.m. per volt, for both sets of deflector plates (where V is the accelerator anode voltage).

Type 4053 is also fitted with a new and improved fluorescent screen making for a better defined trace and greater freedom from "burning."

WRITE FOR LEAFLET WITH FULL TECHNICAL
AND OPERATING DATA

Advt. of The General Electric Co. Ltd., Magnet House, Kingsway, London, W.C.2

Scannings and Reflections

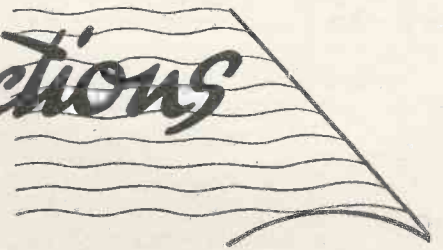

THE RELAY AERIAL

THE St. Pancras Highways Committee has recommended the Council to approve the erection by the B.B.C., of a 150 ft. ultra-short wave receiving mast for television relays on a site on the north-east corner of Swain's Lane and Bisham Gardens.

There has been considerable local opposition to this project on the part of residents and owners of property and a letter in the local Press says: "The only consolation is that in due course interference to transmission caused by vibration from passing traffic and the working of an existing machine motor within a few yards may result in the television mast being moved to a less conspicuous and more suitable site."

TELEVISION MURDER CLUE

Television was used last month for the first time to help to trace a murderer in Berlin. A picture of an overcoat belonging to a man who is wanted was televised on behalf of the Berlin police in an attempt to trace the owner. The coat was found lying beside the body of a taxi driver who was murdered last month in a lonely suburb on the outskirts of Berlin. The coat showed marks of a struggle and as it did not belong to the murdered man, it was assumed to belong to his assailant. The public were shown the coat, which has unusual padding on one shoulder and tailors were asked to attend Berlin's television booths to see if they could identify it.

A NEW LIGHT RELAY (?)

An American has been granted a patent for a new television screen which consists of plate glass to which millions of short hairs are attached. It is claimed that ordinarily the hairs lie at different angles and form an effective screen which will not allow light to pass. A brilliant uniform source of light is to be provided and the hair coated glass scanned by a cathode beam in the ordinary way. The hairs receive varied charges, depending on the intensity of the beam

and the inventor claims that electrically charged hairs have a tendency to stand erect and the effect is as though valves are opened to varying degrees, allowing light of various intensities to pass through the glass screen.

TELEVISION'S SECOND BIRTHDAY

Wednesday, November 2, was the second anniversary of the regular television service from Alexandra Palace. The Television Festival Dinner was arranged for the same day, and as described elsewhere in this issue, was the occasion of a special programme which was witnessed by H.R.H. The Duke of Kent.

WTMJ AND TELEVISION

The Journal Company, New York, which publishes the *Milwaukee Journal*, and operates radio station WTMJ Saturday has filed with the Federal Communications Commission an application for a licence to operate a television station for the purpose of transmitting a regular schedule of programmes. The Journal says that it acts at this time because experiments and investigation have shown that television has developed beyond the laboratory stage and is now ready as a service to the public, and it is planned thoroughly to study television and its programme technique by broadcasting programmes of every conceivable type and kind, and determine the degree of service which television has to offer to the public.

Fifty television sets of various types are to be installed in homes and public places where the programmes may be viewed at the Journal's expense. A power of 1,000 watts is to be used.

TELEVISION AT CHRISTMAS

Television's Christmas season of studio productions will open with Gordon Daviot's historical drama, "Richard of Bordeaux," in the evening of December 18, with Gwen Ffrangcon-Davies in her original part as the Queen. The play will be produced by Michael Barry.

On the following afternoon,

Stephen Thomas will present "The Knight of the Burning Pestle," by Beaumont and Fletcher, an Elizabethan comedy which stages a play within a play, with interruptions from the audience. A high-flown drama of thwarted love is thus reduced to something which has been described as "period panto."

In the evening of December 19, Reginald Smith will present "Review of Revues," featuring Phyllis Monkman, Edward Cooper, Queenie Leonard and other stars of the "Re-view" shows, which have now reached their seventh edition.

Edgar Wallace's detective play, "The Ringer," will be televised in the afternoon of December 21 and evening of December 27. In the evening of December 21 Spike Hughes' burlesque pantomime, "Cinderella," will be presented by Dallas Bower. This was originally broadcast last Christmas.

In the evening of Christmas Day Noel Coward's comedy, "Hay Fever," will be presented by Reginald Smith, with Kittv de Legh playing Marie Tempest's original part of Judith Bliss.

In the afternoon of Boxing Day, "Once in a Lifetime," the brilliant comedy of Hollywood life, by Moss Hart and George Kaufmann, will be presented by Eric Crozier, with Joan Miller and Charles Farrell in the leading parts. This is the first television play to run into five performances.

In the afternoon of December 28, Denis Johnston will present his own play, "The Moon in the Yellow River."

G.E.C. (AMERICA) TO STUDY BRITISH TELEVISION

E. H. Vogel, manager of the radio division of the General Electric Co., of New York, is now in Europe for the purpose of studying television facilities, developments, and experience in Europe, particularly in England, France and Germany. He expects to be here for six weeks, and will not only investigate transmitting and receiving equipment but will

MORE SCANNINGS

discuss commercial television experience and plans with various European agencies and G-E affiliated companies. "We are not primarily interested at this time in engineering or scientific developments related to television," said Mr. Vogel. "What we want to know is how British audiences react, for instance, and how television is set up economically, both for transmitting and for receiving equipment—also what are its effects on radio and motion pictures."

WIRELESS RETAILERS AND TELEVISION

The Wireless Retailers' Association National Council at a meeting held on October 26 discussed the future policy to be adopted towards television. It was decided to call meetings of dealers in the television area to discuss matters relating to television and decide the future policy after these discussions.

TELEVISION IN ITALY

In the plans for Italy's new Broadcasting Headquarters at Milan provision is made for television, and three studios have been designed for visual broadcast.

BRITISH TELEVISION FOR THE EIFFEL TOWER

Extensive changes are to be made in the transmitting equipment at the Eiffel Tower, for a decision has been made to instal the Marconi-E.M.I. system as used at the Alexandra Palace. The apparatus, however, will be supplied by the French Thomson-Houston Co., which controls the rights in France of the E.M.I. Co. The cost is estimated to be £90,000.

AMERICAN FILM COMPANIES AND TELEVISION

Three major film companies in the U.S.A. are linked up with television development. These are RKO-Radio Pictures with R.C.A. Television, Warner Bros. with Trans-American Broadcasting and Television Corp., and Paramount Pictures with Allen B. Du Mont Labs., Inc.

Paramount now owns half of the Du Mont concern and supplies finances for furtherance of Du Mont patents and developments. A Du Mont receiver which it is expected can be sold at a little over \$100 was demonstrated recently.

WIRELESS LICENCES STILL INCREASING

The Post Office issued 1,115,794 wireless receiving licences during October, 1938. This figure represents a net increase of 71,241 in the number of licence holders during the month, after making allowance for expired licences and renewals. This is the greatest monthly increase since January, 1937.

The approximate total number of licences in force at the end of October, 1938, was 8,828,200, as compared with 8,370,410 at the end of October, 1937, an increase during the year of 457,790.

"AN ELEPHANT IN ARCADY"

On December 4 the whole of the cast of "An Elephant in Arcady," Eleanor and Herbert Farjeon's musical play now running at the Kingsway Theatre, will give a television matinée. The large cast includes Irene Eisinger, Frederick Randalow, Percy Parsons, Elizabeth Darbshire, Eric Starling and Linda Gray.

SCOTLAND YARD AND TELEVISION

As a result of the use of television by the Berlin police in the hope of tracing a murderer it is stated that officials at Scotland Yard are studying its possibilities in the location of "wanted" persons.

TELEVISION EXPENDITURE

On November 14 the Postmaster-General (Major Fryon) in a written reply to Mr. Rostron Duckworth, said he was informed by the B.B.C. that the capital expenditure incurred on the television service up to September 30, 1938, less depreciation written off, was approximately £126,000, and that the revenue expenditure up to that date, including depreciation and programme, engineering, and staff costs, was approximately £660,000.

The question of introducing a special licence was reviewed from time to time by the Television Advisory Committee, but they did not consider that such a course would be desirable at the present stage of development of the service.

Major Tryon further said he had no precise information regarding the number of television receivers in existence, but understood, however, that the Television Advisory Com-

mittee received confidential information, from time to time, from the Radio Manufacturers' Association concerning the total number of sets sold by members of the association.

CINEMA TELEVISION

Mr. Wolfe Murray, the new public Relations Officer for the B.B.C. Television Service, speaking on television at the Women's Advertising Club dinner, said: "As far as I know, the Corporation does not envisage anything in the way of a cinema end to it. We do not envisage large halls where people will look at a television on 24 ft. screens. It is purely a service where people look at television by their own fireside. And for that type of entertainment the individual artist rather than large companies is eminently suited."

We understand, however, that a special demonstration is to be given to the Television Advisory Committee.

TELEVISION TALKS IN THE U.S.A.

The latest developments in television in the United States, and particularly the results of experiments and research by the Radio Corporation of America and the National Broadcasting Company, will be described for short-wave listeners during the week commencing December 11 over N.B.C. station W3XAL.

Dr. Fernando de Sa will be heard on Tuesday, December 13, from 5.45 to 6 p.m., EST, speaking in Portuguese, and Roberto Gatica on Friday, December 16, from 6.45 to 7 p.m., in Spanish. Both speakers are members of the N.B.C. International Division staff.

Their talks will be of particular interest in view of the fact that manufacturers in the United States now believe that television programme service, a field in which N.B.C. has pioneered, has reached a stage that will prove satisfactory to the public, and consequently expect to begin manufacturing television receivers for public distribution by next spring.

AUSTRALIA AND TELEVISION

Proof of the interest in television in Australia is furnished by the experience of the British General Electric Co. (Pty.), Ltd., at Sydney. The company recently imported two types of television sets consigned by the parent company, the G.E.C. of England. The object was primarily to

AND MORE REFLECTIONS

exhibit them for prestige purposes—as evidence of the important contribution made to television progress by the G.E.C.

Instead of confining an exhibition of the two sets to its own spacious showroom windows, the B.G.E.C. sought the co-operation of one of Sydney's largest emporiums. A display was staged which attracted large crowds day after day. Both sets were shown. In the case of the larger one, television reception was simulated by projecting on to the screen, from a hidden source, a sub-standard motion picture film. The chassis of the smaller set was removed from its cabinet to show the interior. Numerous photographs of the British television service being recorded and transmitted, with explanatory captions, were also shown. The interest of the public in these exhibits showing what is being done in England has been so great that the B.G.E.C. has decided to display the two television sets for various periods in many important towns throughout Australia.

TELEVISION IN WAR

It has been known for some time that experts in Germany have been studying the use of television in time of war and on this account for a considerable period there was a great deal of reticence regarding television development in that country.

American experts, it is now stated, have also turned their attention to the matter. Television cameras installed in planes and balloons, or on hills overlooking enemy territory, it is thought, would be able to transmit to staff headquarters information of enemy activities.

SCOPHONY IN U.S.A.

Considerable interest has recently been shown in Scophony large-screen television developments by some leading American radio and film interests. In this connection Mr. S. Sagall, founder and managing director of Scophony, Ltd., is now in America with the object of negotiating for a company there to take over the Scophony U.S.A. patent rights.

Incidentally, Mr. Sagall has been trying hard to get the Board of Trade to sponsor a representative British television exhibit in the British Pavilion at the New York World Fair; patent difficulties, however, affecting

the majority of the proposed television exhibitors have apparently arisen, and the project has fallen through. Mr. Sagall will try while in New York to arrange for an independent Scophony exhibit at the World Fair.

DON LEE BROADCASTING
SYSTEM SELLS PATENTS RIGHTS
TO R.C.A.

The General Manager of the Don Lee Broadcasting System has announced the sale of certain patents to the Radio Corporation of America. The patents cover inventions made by Harry R. Lubcke, Director of Television for the network, and include rights in the United States, Canada, Germany and Great Britain. The Don Lee System has reserved a licence to make, use or sell equipment embodying the principles of the patents in the several countries. The inventions involved are chiefly concerned with synchronising and cover means utilised at both transmitter and receiver.

The Don Lee television transmitter W6XAO has been on the air daily except Sundays and holidays since 1931. Ten and a half million feet of motion picture film has been televised and now, with a power of one kilowatt both studio and film broadcasts are made on regular schedule.

THE VALUE OF LOW TRANSMITTING POWER

The well-known British amateur, G8MX, has been proving in no uncertain manner that the higher frequencies can be used for long-distance communication with very low power. With an input of 1 watt using a 100-volt dry battery he has been having two-way contacts with American amateurs on a wavelength of 10 metres.

On November 20th he contacted W8DST and received a QAS4 R5 report using a supply of 48 volts at 6 mA. equal to an input of .28 watt. Several other 10-metre stations have been worked on inputs of 2 watts while telephony has been used in each case.

"Television and Short-wave World"
circulates in all parts of the world.

ALEXANDRA PALACE IN
CHICAGO

Despite the fact that the Alexandra Palace sound transmissions on 7.23 metres are supposed to be quasi-optical, reports are still being received from long distances. The latest verified report is from near Chicago where W9ZHG is claiming consistent reception with a signal level of about 78 db. and free from noise. This reception has been consistent for the past three weeks so that now the Alexandra Palace transmissions are used as a marker and should they be received at good strength W9ZHG knows that the U.H.F. bands are open.

It is hoped that W9ZHG will be able to record these transmissions and to relay them back to Europe on the 28 mc. band.

MICRO WAVES FOR ALTITUDE
MEASUREMENTS

The normal system of measuring the height above ground of an aeroplane is not strictly accurate for if the plane is 500 ft. above a mountain of 2,000 ft. it shows the altitude of 2,500 ft. Two Japanese engineers have designed a direct reading radio-wave reflector calibrated in feet. This meter registers the height of the plane above the nearest surrounding objects so that it is invaluable when the plane is flying in mountainous country. A completely continuous indication of altitude by a steady pointer and dial is easily accomplished and altitude variations occurring during time intervals of a few milliseconds are clearly detected. It is accurate down to a height of only 14 ft. and the power consumption is only 3.9 watts.

CINEMA TESTS

The Television Advisory Committee were recently shown a demonstration of large screen television installed by the Baird Company at the Tatler Theatre, London.

This is an initial step in the hope of removing the ban which now prevents the public showing of the television programmes in places of public entertainment.

The study of television, broadcasting and film stagecraft is to be introduced at the Guildhall School of Music and Drama.

DECEMBER, 1938

SIR NOEL ASHBRIDGE (CHIEF ENGINEER B.B.C.) ON THE FUTURE OF TELEVISION

On November 4 Sir Noel Ashbridge gave the Thomas Hawksley Lecture before the Institution of Mechanical Engineers and the following is an abstract of the concluding part in which he dealt with the future possibilities of television.

SIR Noel opened his lecture with a brief historical survey of the development of television and then went on to explain the principles and apparatus used. He concluded by surveying future possibilities and probable trend of progress.

In any consideration of the lines on which television is likely to develop in this country, he said, one should perhaps begin by reviewing the results obtained under present conditions. One of the most important questions is, of course, the extent of the territory which can be covered. The Television Committee originally estimated that the London station would be effective up to a range of about 25 miles. The map shown here gives a rough indication of what might be considered the limiting range, based on measurements, and from this it will be seen that the committee's estimate has been materially exceeded. Not merely has it been exceeded on a basis of average range, but it has been found possible, under favourable circumstances, to obtain reception at very much greater ranges, of the order of two or three times that originally estimated. Various points where good reception has been obtained beyond what might be called normal range are indicated on the map. In any case it is clear that a population of some ten million people at least now have the opportunity of receiving regular television programmes, if they are able to provide themselves with receiving sets.

With regard to the probable range of future stations, this must depend to a large extent on three factors. First, the maximum power which it will be possible in use, second, the nature of the country which has to be served, and third, the wavelength channels which will be available.

Effect of Increased Power

With regard to maximum power there seems no reason to doubt that it would be possible to erect a station with three or four times the power of the existing station, but it must be

remembered that this only means that the strength at any equivalent point would be at the most double what it is with the existing power. Nevertheless it would increase the range by an appreciable distance. Then with regard to the nature of the country, in most of the densely populated areas in the provinces the country is more hilly than in the neighbourhood of London, and the extent to which this would adversely affect the performance of a station is at present difficult to estimate, but it must to a large extent prevent too optimistic an estimate particularly as applied to, say, Scotland, or the North of England.

Available wavelengths are the sub-

ject of international agreement, and briefly, the position at the moment is that one more station could be operated on a wavelength of a similar length to that now used, namely, 6 to 7 metres, but distinct from that employed at the Alexandra Palace. There is a possibility that, by agreement with neighbouring countries, a third separate channel of this type might be used. For any further stations beyond this number, however, it will be necessary either to place more than one station on the same channel, or at any rate on overlapping channels, or else to use a considerably shorter wavelength, which it may be expected would give a more or less limited coverage.



Map of Service Area of London Television Station.
 - - - - - Outer limit of normal reliable service area.
 X Localities outside service area where good television reception has been experienced.

POSSIBILITY OF RELAYS

According to the new wavelength agreement which comes into force in September, 1939, it would be permissible to use one channel in the neighbourhood of 5 metres, and two more in the neighbourhood of 3 metres, and some live more in the neighbourhood of $1\frac{1}{2}$ metres. This is, of course, in addition to the two or three channels in the neighbourhood of 6-7 metres already mentioned. According to present knowledge it would seem probable that satisfactory results could be obtained in the neighbourhood of 5 metres.

The outside broadcast link transmitter works on such a wavelength, and good results are obtained, but there is no doubt that when using such wavelengths it would be even more necessary to ensure placing the station on high ground, using a high mast. When lower wavelengths still are considered it must be expected that more screening from buildings and hills will be experienced, and it seems perhaps doubtful whether wavelengths as short as $1\frac{1}{2}$ metres will be found to be usable for a broadcast service, except perhaps for comparatively restricted services where practically a visual path can be obtained.

Relay Stations

Another highly important question is the means of linking one station with another. It would be perfectly possible to operate a number of stations entirely independently of each other, by radiating separate programmes from each, or by using film material produced in central studios. Here one must consider the financial and practical aspects, and the high cost of separate programmes on the one hand and the inconvenience of recording all television programmes on films on the other, would seem to point to the fact that linking between stations will be essential if a country-wide service is to be operated on a reasonably economical basis.

There are two possible ways of linking stations separated by a considerable distance, that is to say of the order of 100 miles or so. One is by special cable, and the other is by some form of wireless link. One type of special cable (balanced twin type) has already been mentioned in connection with outside broadcasts;

there is, however, another type of air-spaced cable, which has been developed primarily for multi-channel telephony. This is known as the concentric cable and it consists essentially of a conductor within a metallic tube and insulated from it by air spacing.

For transmission over such a cable it is necessary to use a high-frequency carrier which is modulated by the modulation voltages in exactly the same way as for wireless transmission. It is not necessary, however, to use high power—in fact a power of a few watts is sufficient. Any convenient frequency may be used for the carrier since no disturbance in the ether can result from cable transmission. The difficulty of cable linking generally is not only the high cost of the cable itself, but also the frequent repeater points and the relatively complicated apparatus which is necessary at such points, and at each end of the cable. There are also technical difficulties in providing for the wide band of frequencies.

On the other hand, there are great advantages in that no ether space is occupied, and the success of the transmission is not subject to interference from motor cars or some other cause. It may even prove impracticable, however, to transmit the necessary wide frequency band over long cables with absence of phase distortion, particularly with the concentric type of cable using a carrier current.

Wireless Link

The wireless link method has certain advantages from the point of view of simplicity and the faithful transmission of a wide frequency band. On the other hand it may be difficult to find a suitable waveband in which to place the linking transmitters. Again, the selection of sites for stations might be a matter of considerable difficulty if very short wavelengths were to be used. There is also the danger that under certain atmospheric conditions distortion of the picture might result from some kind of fading effect arising from reflections of the transmitted signal.

It would, of course, be necessary to confine transmission for linking purposes to a method employing narrow beams rather like a searchlight projector, and one may visualise the system as consisting of a number of

transmitting and receiving stations each working from one hilltop to another about 50 miles apart. Both these methods of linking are now under active consideration, but considerable experimental work will be necessary before either can be used on a practical basis.

Picture Size

The next question to consider is the fundamental one concerning the quality of the picture which can be produced. At the present time an excellent picture can be obtained of a size measuring, say, 10 in. by 8 in., using apparatus which is available commercially. The degree of definition (which depends, of course, on the number of lines used, as already explained) is such as to allow this picture to be viewed at a distance of 5 or 6 ft., without the imperfections due to lack of definition being objectionable to the average viewer. The definition, however, is not equivalent to what is obtained on the cinematograph screen and, owing to the wide popularity of the cinema, this fact is inclined to put television at a disadvantage, although one cannot regard the two forms of entertainment as being in competition.

To produce television with the same order of definition would necessitate the use of something like 1,000 lines, which in turn would mean the employment of a very much wider band of frequencies, introducing severe difficulties in the design of the transmitting and receiving apparatus. But what is perhaps even worse, it would necessitate the setting apart of a very much larger space in the ether. It must be remembered that there is now very severe competition between the various wireless services for permission to use wavelengths of the kind suitable.

The Television Committee has announced that the present standards will remain in operation for at least three years. One may, therefore, look upon present standards as being permanent for some considerable time to come. Moreover, there is some possibility of a gradual increase of definition up to a certain limit by improvements both at the transmitting and receiving ends, without any alteration in the number of lines. It is important to note, also, that such

(Continued on page 740)

Television Digest

Interesting Abstracts from the World's Television Literature

The Electron Microscope Electronics (New York)

THE great importance of the electron microscope lies in the fact that it extends the magnification and resolving power considerably beyond that obtainable with the visual or even the ultra-violet microscope.

The practical limit of magnification with the visual microscope is about 2,000x, whereas with the ultra-violet microscope, magnifications of 6,000x have been attained. Magnifications of as much as 30,000x have been obtained with the electron microscope, and the resulting photographs are sufficiently sharp and clear to permit an additional optical enlargement of 3x. Thus is it possible to obtain magnifications of the order of 100,000x and thereby make visible the form and outline of bacteria, viri, colloids and other very small particles which, up to now, could be detected only by the effects they produce.

The *modus operandi* of the electron microscope is indicated in the diagram which also shows the corresponding optical analogue. The essential elements consist of a source of radiation, the electron-optical system composed of properly constructed electric or magnetic fields which refract the electron beam, and the necessary screens or photographic plates for making visual or photographic observations.

The source of electron radiation, corresponding to the light source in the visual microscope, may be either a hot or a cold cathode. The emitted electrons are accelerated with voltages which may be as high as 100,000 volts. The high-voltage electron beam is necessary to obtain the high resolving power and magnification which is the main advantage of the electron microscope. The useful portion of the beam passes through an aperture in the anode after which it is acted upon by a condensing coil which condenses the beam in a manner similar to the collimation of the light rays in the optical system.

The condensed beam then impinges upon the object under observation which is held in a special locking and adjusting chamber since the object is contained within the vacuum system

of the microscope. The electron beam is then refracted to form an image on a fluorescent screen in the intermediate image plane. This intermediate image is specially useful when making preliminary adjustments, since it is observed and accurately focused at relatively low magnification. In the Siemens' instrument, the magnification in the intermediate plane is about 80x.

By means of an object shifting device, that part of the image which is to be further magnified is brought over an opening in the centre of the intermediate screen. The electron rays for this part of the image are then condensed by a projection coil in such a way that the intermediate image is further magnified as much as 350x. The resultant magnification is the product of the magnification of the individual electron-lens systems. The final image, which may

be magnified as much as 30,000x, may be photographed directly from a fluorescent screen which also makes the image visible, or, as is done in the Siemens' instrument, a photographic plate may be introduced within the vacuum system of the microscope and an image can then be formed by the electron beam falling directly on the photographic plate.

The most important parts of the microscope are the electron lenses, for the refraction of the electron beams in traversing the electric or magnetic fields provides the basis for electron microscopy. Unlike light optical lenses, the refractive indices of electron lenses are not constant for a given medium. The electron lenses may consequently be regarded as possessing varying indices of refraction, depending upon the electric or magnetic constants of the system. As a result, the focal length of the electron lenses is not fixed, but may be adjusted by varying the electric or magnetic fields of the electron lens.

It is customary, where large magnifications are required, to use magnetic fields for bending the electron beams. Lenses of short focal length,

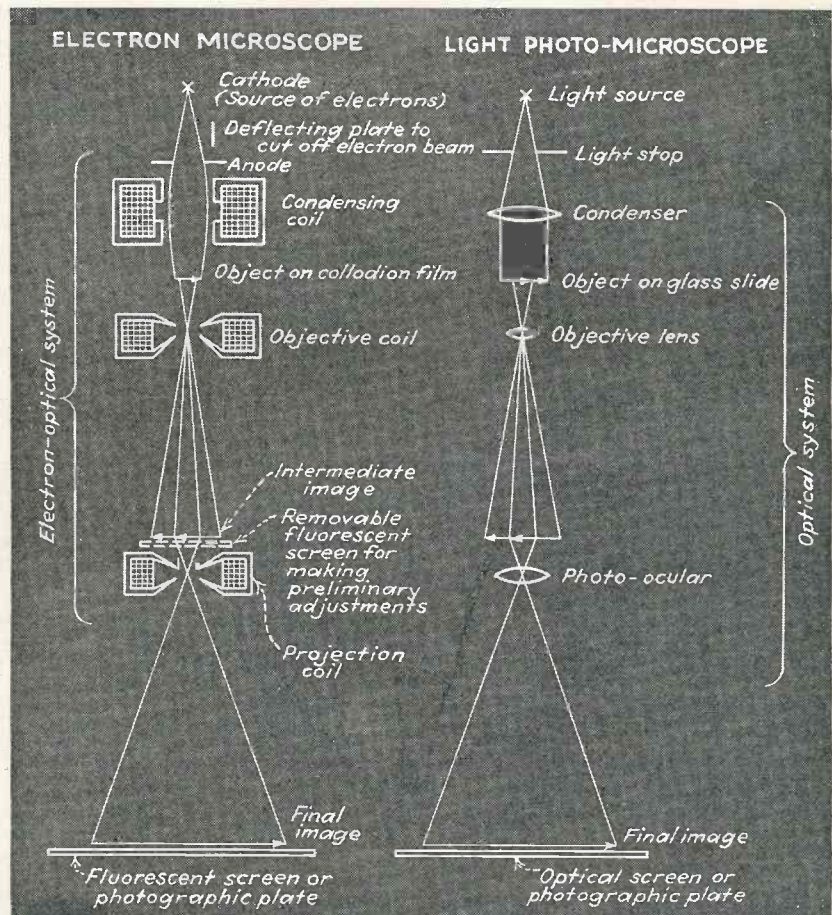

Diagram showing the geometric optics of the two-stage electron microscope and its optical counterpart.

which are required for large magnifications, are obtained by large magnetic fields, i.e., by increasing the current through the coils, or by using coils of many turns of wire. The shape of the ferro-magnetic circuit, and the use of materials of high permeability, with proper distribution of air gaps, is an important consideration in designing a practical electron-optical lens system for electron microscopes. To maintain the focal lengths of the electron-optical system sufficiently constant during the time necessary for the exposure of the photographic plate, the current through the various coils must be maintained to a high degree of precision, for current variations would produce various types of aberrations and distortions.

Due to the large magnifications obtained, great care is required in the design and construction of the component parts of the microscope. Since the object may be magnified as much as 30,000x, a horizontal displacement caused by vibration and amounting to only 10^{-4} mm. would result in displacements or variations of as much as 3 mm. on the photographic plate; such swings would make it impossible to obtain sharp images of the object.

In order that the form and mass distribution of the object may be determined, it is necessary that the object be suspended on some electron-optically transparent substance, much as the object in a light microscope is placed between transparent glass slides on the mechanical stage. The medium selected for the electron microscope should be characterised by low absorption of the electron beam, ability to withstand the effects of the beam for fairly long periods of time, and appreciable mechanical strength. These requirements can be met by selecting a high accelerating potential for the electrons, and employing a very thin membrane of only 1/100,000 mm. thickness for the support of the object under observation. Highly satisfactory membranes may be made of a weak solution of collodion in amyl-acetate which is dripped on a large surface of water. The amyl-acetate evaporates quickly and leaves a thin film of collodion on the water. Then the water is drained from the bottom of the container and the collodion is allowed to set over an aperture of perhaps 0.03 to 0.3 mm.

The object to be observed is placed on the extremely small surface of the

stage. Then the microscope is focused by means of a suitable trial object or fine wire mesh so that after inserting the real object through the locking chamber, only a slight amount of further adjustment is required.

Those Lines (Murphy News)

Should "lines" be visible in the television picture?

All television pictures received from Alexandra Palace must be made up of the 405 lines which are transmitted, and the only factor that can be controlled at the receiving end is the size of the scanning spot. If now we consider the spot size to be more than 1/405th of the picture height in diameter the inter-line spaces will be filled up and the lines themselves will be much less visible. Unfortunately, an inevitable disadvantage crops up here, as in many other things, in that the definition will be correspondingly less.

What really has to be decided, then, is a compromise between picture definition and line visibility. Means for the user to settle this compromise are provided by the focusing control by which he can vary the spot size.

"THE FUTURE OF TELEVISION"

(Continued from page 738)

improvement would not cause any upheaval in design or method of working, and would not render existing receivers obsolete.

Frequently the question of a much larger picture has been discussed, and it has even been said that it is essential to have larger pictures for viewing in comfort. It is felt, however, that this is not by any means a sound argument. Since we must assume that the practical minimum limit to the distance at which a picture is viewed depends to a large extent (although not, of course, entirely) on the degree of definition, there is no reason why a picture of 10 in. by 8 in. should not be viewed at a distance of, say, 2 or 3 ft., if the definition allows, as when looking at an ordinary photograph. On this basis, it does not seem likely that one would wish to look at a picture in the home measuring, say, 2 ft. by 3 ft., any more than one would wish pictures in an illustrated magazine to be of this size.

On the other hand, were large pictures made available there is no

doubt that some people would prefer them, but they would probably find it necessary to place themselves at a correspondingly greater distance. It does not seem sound, therefore, at any rate scientifically, to say that television will not be satisfactory until a large picture is available. It would be more logical to say that the definition was insufficient to convey sufficient information.

Finally, the rate of development of the service must perhaps be considered, and it should not be regarded as a reflection on the possibilities of television that development has not been so rapid as that of sound broadcasting. In the case of the latter, a large service area could be covered with a single small transmitter of very low capital and maintenance costs, while on the programme side there is no equivalent in television for the simple inexpensive type of programme such as can be produced by a small orchestra.

For television a great deal of rehearsal is necessary for practically every programme, while the artists must both learn and look the part they are playing. Still more important, however, is the cost of receivers. Sound broadcasting was built up largely on the use of crystal receivers costing £2 or £3, whereas the cost of a television receiver cannot be expected to approach such a low figure.

There is one aspect of television development which must be recorded with regret and that is that there seems no likelihood of international standardisation with regard to definition and picture frequency standards. It is true that no serious attempt has been made so far to bring this about, but the unfortunate fact remains that in the following countries the standards at the moment are as follows, although there is as yet no public service:—

	Lines per picture.	Pictures per second.	Modulation
America	441	30	negative
Germany	441	25	positive
France	455	25	positive

It may be that in the distant future international television cables may become available and then the absence of a common standard for European countries might become a serious matter.

There is no doubt that this new development of entertainment in the home will, in the course of time, reach the same degree of importance that sound broadcasting has done.

HOW THE PICTURE IS SYNCHRONISED—II

In the second article of this series, G. Parr describes the method of separating the line and frame pulses and gives further examples of synchronising circuits

AN observant reader has pointed out that the diagram of Fig. 5 in last month's article was not strictly correct, in that the connection to the diode synchronising separator was made from the cathode of the video amplifier. The grid is returned to the -ve H.T. line, with the result that there will be "negative feedback" and the output will be negligible. This is quite true, and the revised diagram, with additions, appears in Fig. 1 on this page.

The cathode bias resistance proper is the one marked AB, the grid being

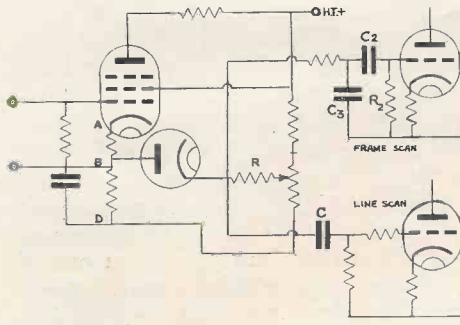

Fig. 1.—Completed diagram showing how the synchronising pulses are applied to the scanning generators.

returned to the lower end, while an additional resistance BD provides the necessary potential drop for the synchronised signal. It should be noted that the screen current flows through this resistance and that therefore any fluctuation in potential, such as is caused by the synchronised pulse, is liable to affect the screen potential. This can be minimised by connecting a condenser across the resistance as shown. The value of this condenser must not be too high, or the shape of the pulse developed across the resistance will be affected, and .0005 is ample.

We can now consider the remainder of the circuit which feeds the pulses to the grids of the scanning generators. The pulses, free from picture content, appear across the load resistance of the diode R. The value of this resistance is also important, as it is common to both the line

and frame pulses and if it is too high there will be a tendency for the line pulse to affect the frame scanning generator. About 20,000 ohms is a usual value.

From the cathode end of the resistance a connection is made to the grid of the line scanning generator through a small condenser C of .00005 mfd. The grid circuit of the thyatron has the usual leak to H.T. -ve and a stopping resistance of 50,000 ohms connected to the grid itself. The object of this is to prevent any pulse developed in the grid circuit from affecting the frame scanning circuit. When a thyatron strikes there is a momentary "kick" of grid current which would be quite sufficient to feed back into the frame scan circuit via the common coupling resistance.

Frame Pulses

The pulse for operating the frame scanning generator is derived from the half-line pulses which occur at the end of each frame, and the circuit for applying these to the scanning generator is slightly different from that just described. Since both the line and frame pulses appear across the load resistance R they will be both applied to the grid of the frame scan generator, and it will be necessary to arrange the circuit so that it will discriminate between them. One method of doing this is to use the so-called "integrating" circuit, in which the half-line pulses are built up or integrated in a condenser. The grid of the frame scanning circuit is connected to the load resistance R through a large condenser C² of 0.1 mfd., the grid leak R² being 100,000 ohms.

Across this combination a condenser C³ acts as a by-pass for the line synchronised pulses, its value being .001 mfd.

Referring to Fig. 2, the pulses at the end of the frame are shown in the lower part of the diagram. The potential across the resistance R² will depend on the charge of the condenser C² and this will receive a pulse of voltage at each synchronising pulse

during the operation of the line scan. The upper curve, marked "Volts across R²" shows these pulses occurring during the last few lines of the frame. At the end of the frame the line synchronising pulses become broader and the condenser potential begins the rise, with a corresponding rise in potential across R². This is shown by a sudden climb upwards of the voltage curve. During the pauses between the half-line pulses the potential drops slightly, but continues its upward climb until the value is sufficient to trip the discharge of the thyatron. This discharge point may occur anywhere on the "climbing" curve, as it is governed by the bias of the thyatron grid. If the bias is too high the curve will be nearly at the maximum before the discharge takes place, but there are still five or six black lines in the frame before the picture starts again and the frame scan will have time to recover from the discharge.

Interlacing

Provided that the frame and line pulses arrive at the grids of the scanning generators at the correct time intervals and are not appreciably dis-

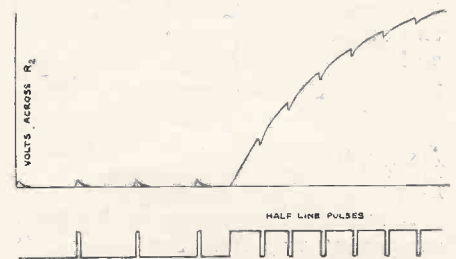

Fig. 2.—The operation of an "integrating" circuit for frame synchronising pulses.

torted, the frames should interlace satisfactorily.

Failure to interlace is usually attributable to interaction between the scanning circuits or to mains interference. The latter is most commonly a cause, owing to the fact that the transmission is on a controlled frequency supply and the majority of television receivers operate on the same mains. If there is sufficient

ripple in the H.T. supply to the scanning generator the frame will be tripped at the same point each time owing to a rhythmic drop in H.T. voltage at the end of the frame. The remedy for this is obvious—extra care in the smoothing of the H.T. supply, and protection from hum pick-up in the leads from the receiver. The

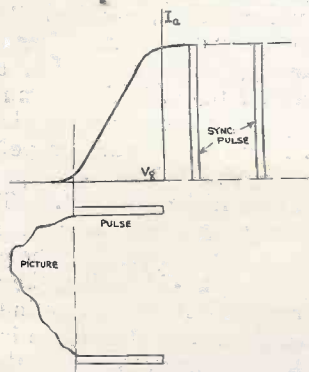

Fig. 3.—A screen grid valve can be used as a synchronising separator, but the D.C. level must be maintained.

interaction between the two scanning generators is inevitable to a certain extent if a common coupling resistance is used in the separator circuit, such as the one described, and the only method of reducing the coupling is to keep the resistance as low as possible consistent with sufficient potential being developed.

A better method of ensuring complete separation is to use separate diodes for the line and frame impulses, but this is extravagant. Special forms of valve have been developed by the Cossor Co. in which two anodes are used, one for the line and one for the frame circuit and these will be considered under amplitude limiters.

Amplitude Limiters

Before the importance of the D.C. component was fully appreciated, it was common practice to use a screen-grid valve as a sync. pulse separator, the picture content being separated from the sync. pulse by adjusting the signal so that the anode current only flowed during the sync. pulse. A common arrangement was that shown in Fig. 3. By setting the anode potential of the valve at a lower value than that of the screen, the characteristic was given a sharp cut-off at the top as well as the bottom, and anode current was limited to a definite value whatever the value of swing applied to the grid.

If the combined picture and synchronising signal is applied to the grid of such a valve it is possible to separate the sync. pulses by ensuring that the picture signal carries the grid bias beyond the cut-off point, as shown in Fig. 3. This arrangement, however, is only satisfactory if the D.C. level of the signal is maintained. If the D.C. level is absent, it is possible to include part of the picture signal in the sync. pulse as shown in Fig. 4.

To understand this, it must be remembered that the condenser feeding the grid of the valve will alter its mean potential according to the average level of the signal and if the preceding line signal is full white the amount of pulse applied to the grid is altered. This method of deriving the sync. pulse frequently gave rise to irregular running of the scanning generator, the synchronising depending on the content of the previous line.

If the grid of the screen-grid valve is directly connected to the video output valve, or to the diode load resistance, the D.C. level is maintained, and the pulses are separated correctly as in Fig. 3. This method of separa-

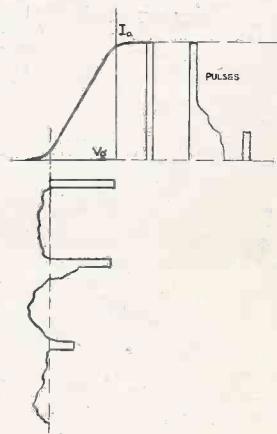

Fig. 4.—If the valve is used without D.C. level the pulses will not be uniform as their amplitude will vary with the picture content

tion is in some respects superior to that using the diode as there is the additional gain introduced by the S.G. valve and the amplitude of the pulse is greater.

The Cossor valve mentioned previously is of the S.G. type with two anodes, one serving the line scan and the other the frame scan.

The possibility of interaction between the scanning generators is thus minimised and the circuit is no more expensive than one using two diodes.

The Physiology of the Eye

A LECTURE of particular interest to all concerned with motion picture production was given to the British Kinematograph Society on November 7 by Prof. D. T. Harris, M.D., D.Sc., Professor of Physiology at the London Hospital Medical College. His subject was "The Physiological Aspect of Motion Pictures."

Prof. Harris' talk made it clear that electrical impulses were the motive source of the nervous system. He commenced with a demonstration of the actual current, with a voltage of about 0.1 millivolt, which a frog's heart generated at each beat; the optic nerve generates similar impulses, which it transmits to the brain.

The eye, said Prof. Harris, is about 300,000 times more sensitive than the finest radiometer. It can deal with a range of visibility of from 1 to 20 billion. The greatest diameter of the pupil is 8 mm. and the smallest 2 mm.; a mean diameter of 3.5 mm. corresponds to an aperture of $f/5$ on a camera lens.

Prof. Harris described the construction of the eye, and especially of the retina. In the fovea or centre of vision there are $3\frac{1}{2}$ million out of the eye's five million cones, which provide colour and detail vision. The rods, which predominate in the periphery of the retina, are responsible for grey vision.

Visual Lag

The dilation of the pupil is of interest to the kinematograph engineer. Going into the dark, the eye wastes a fifth of a second, then it gradually opens out; during the first 20 seconds there would be appreciable opening, but it will take three minutes to become fully dilated. The sensitivity of the eye may vary by 300,000 times.

Curves were shown of the response of the eye to sudden stimulation, leading to a consideration of flicker perception. With a light intensity of 100 lux about 45 pulsations per second are needed to eliminate flicker; at lower levels 16 per second is adequate.

Prof. Harris concluded his talk by a consideration of the emotional response to films, and showed a film as a test.

Telegossip

A Causerie of Fact, Comment and Criticism

By L. Marsland Gander

DURING October 1,800 television sets were sold in the London area. This is the biggest fillip television has had since the B.B.C. began transmitting in the autumn of 1936, and incidentally they are the first authentic figures of television sales that have ever been published.

The trade, for some reason, has always concealed the figures relating to television sales or lack of sales. No one was ever deceived for a moment by this ostrich policy. After Alexandra Palace had been transmitting for eighteen months it was revealed that fewer than 2,000 sets had been sold to the public. Now nearly as many are being bought in a single month, and the sales graph is climbing steeply.

New York is starting a public service next spring, coinciding with the opening of the World's Fair, and Transatlantic interest in television is bound to have a stimulating effect here. American experts sent over here to study British television put the question to me: "What has caused the London public to change its mind over television and to start buying?"

Television Finance

The answer I make is, "Better programmes, cheaper sets, improved picture quality, and the overcoming of small screen prejudice." The B.B.C. must now be spending nearly £400,000 a year on its television service, and I exclude capital expenditure. This outlay is at last beginning to bring returns to the set manufacturers. Soon it will be paying dividends.

But I find it remarkable, in face of the ever mounting cost, that the Television Advisory Committee should still be bogging over the question of an extra ten shillings licence fee for television. Few persons ready to pay from £30 to £80 for a television would resent another ten shillings a year and there is already the precedent of the car radio licence. When provincial stations begin to sprout the committee may be forced to do something to find more money, and then it may be too late to propose an increase of the licence fee without risk of an outcry.

People are seldom willing to pay

for what they have once had for nothing. It is one thing to increase the licence fee at the outset when there are only a handful of viewers and quite a different proposition to attempt to do so when there are 50,000 or 100,000 televisioners in use.

Another problem due for early consideration by the Television Advisory Committee is the site of the first provincial transmitter. The choice should fall on Manchester. In a recent lecture Sir Noel Ashbridge commented on the possibility of a station using much higher power than Alexandra Palece. He did not envisage any great extension of the service area, but even the conservative B.B.C. engineers must now admit that the 25 miles estimate was too cautious. The importance of higher power is not so much an extension of the range as the provision of a stronger signal, less subject to interference, in the service area. In my opinion the best site for England's second station lies on the high ground between Manchester and Leeds, where the transmissions could cover the most populous districts of Yorkshire and Lancashire—Bradford, Barnsley, Huddersheld, Halifax, Rochdale and Wakefield, besides Manchester and Leeds. Go to it, B.B.C.

Making History

After the first television transmission from a theatre the B.B.C. Television Director was Mr. Gerald Cock a Whoop. He and Mr. Basil Dean, the enlightened producer who gave permission for the transmission, received several hundred letters of congratulation. On the day after the transmission the Queen visited St. Martin's Theatre and one wonders whether Her Majesty had seen the play on the television screen.

At any rate, since then the advance bookings have been exceptionally heavy, and the B.B.C.—Theatre axis has been greatly strengthened. This is fortunate, for everything points to the fact that plays and outside broadcasts are the most successful programme features. In fact, during these winter months drama is leading the topical outside broadcast in popularity.

The transmission of "When We Are Married" from St. Martin's had

enormous publicity and "stunt" value but it must be admitted that the play could have been done better from the studios and with far less trouble. Forty kilowatts of extra lighting had to be installed in the theatre. Rows of seats had to be moved to set the camera platforms in the front of the stalls and the centre of the dress circle.

Mr. Basil Dean said there was too much interference with the normal routine of the theatre to allow such experiments frequently. Still, apart from the distant booming of a set in the bar, a faint buzz of instructions that could be heard coming from the headphones of the camera men, and a shuffling to and fro at the back of the theatre I doubt whether the audience was greatly inconvenienced. And it was the audience, whose warmly spontaneous applause made a living contact with the actors, that provided the important difference between this and a studio show.

Anyhow, a play a night till further notice is the B.B.C.'s ideal and so long as sales go up it will be abundantly justified. The theatres are co-operating by permitting the performance of many current plays in the studios. In the meantime there is not the slightest possibility of an increase in studio hours of transmission in the near future. Such increases as we may have will be accomplished by the mobile units.

The Questionnaire

While on this topic of programme preferences I am reminded that in the early days of A.P. Transmissions forms were circulated to any who asked for them to take a census of opinion. Only about seventy forms were filled in because the inquiry was premature. To-day there would be several thousand replies and I suggest that the B.B.C. revive the idea.

One of the best compliments paid to British television is the purchase by the French Post Office of the Marconi-E.M.I. system of transmission for broadcasts from the Eiffel Tower. Most of the apparatus has been made in France by the French Thomson-Houston Company. The pity is that it adds to the international definition muddle, for Eiffel Tower will not be using the B.B.C.'s 405 lines nor the 441 lines of Germany and America.

RECENT TELEVISION DEVELOPMENTS

A RECORD OF PATENTS AND PROGRESS Specially Compiled for this Journal

Patentees : Baird Television, Ltd., and A. J. Brown :: Baird Television, Ltd., and J. L. Baird :: A. D. Blumlein and C. O. Browne :: Telefunken Ges für drahtlose Telegraphie m.b.h. :: E. Michaelis :: Marconi's Wireless Telegraph Co. Ltd. :: The General Electric Co. Ltd., L. C. Jesty and J. Sharpe

Television Transmitters (Patent No. 489,716.)

IT is usual in transmitting a television programme to superimpose the picture signals on the carrier wave after the latter has been modulated by the synchronising impulses, because this tends to prevent loss of the higher-frequency pictures, particularly in the latter stages of amplification.

Since the synchronising signals occupy a much smaller frequency band than the picture signals, it is found more economical, so far as power is concerned, to superimpose the synchronising impulses upon a wave of a lower frequency than the normal carrier.

Accordingly the "timing" signals are applied to a comparatively low-frequency oscillation, and this is then passed through a frequency-multiplier before the picture signals are added to it.—*Baird Television, Ltd., and A. J. Brown.*

Kerr Cells

(Patent No. 489,964.)

In order to attain a strong electrostatic field, it is necessary to place the electrodes of a Kerr cell close together. It then becomes difficult to direct the ray of light to be controlled through this narrow space, and at the same time to prevent it from striking against the electrodes, where it is liable to be reflected or "scattered."

To overcome the difficulty, the electrodes are both made transparent so that any light that strikes against them passes clean through and does not interfere with the ray to be controlled. The transparent surface is obtained by depositing an extremely thin layer of platinum or tungsten upon a backing-plate of glass or mica.—*Baird Television, Ltd., and J. L. Baird.*

Preventing "Tilt"

(Patent No. 490,205.)

One effect of low-frequency inter-

ference on a cathode-ray television transmitter is to produce what is known as "tilt." In other words each scanning line is given a false "boost" towards one end, so that the resulting signals have the form shown at A instead of that shown at B. The result in the receiver is to cause the picture to appear "lopsided" in the sense that it seems de-

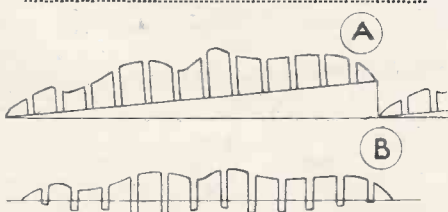

Method of preventing tilt, Patent 490205.

finitely brighter at one end than the other.

In order to compensate for this, the picture is cut up into vertical strips by a grid-like member, which is placed in front of the mosaic screen at the transmitter. The strips are

the mosaic screen do not retain the same position but are "interlaced." This prevents any risk of their being reproduced on the viewing screen at the receiving end.—*A. D. Blumlein and C. O. Browne.*

Time-base Circuits

(Patent No. 490,529.)

Scanning voltages of equal and opposite polarity are applied to the deflecting plates P, P₁ of a cathode-ray tube by the discharge of a condenser C through a gas-filled tube V. The condenser C is connected in series with equal resistances R, R₁, across a single D.C. supply.

When the valve V is "flashed" by synchronising impulses applied at A, the condenser C discharges, and causes the voltages on the deflecting plates P, P₁ to vary in "push-pull."

It will be noticed that both the deflecting plates are connected to earth through resistances R₂, R₃, the time constant of these resistances and the blocking condensers C₁, C₂ being larger than the saw-toothed period.

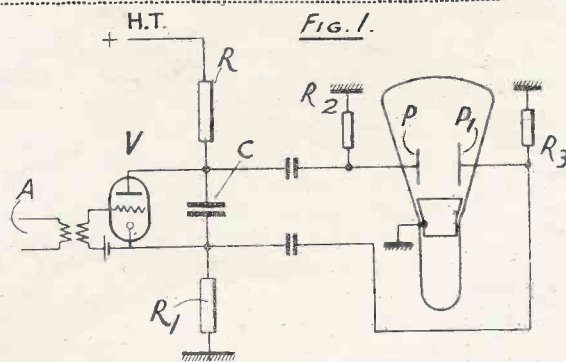
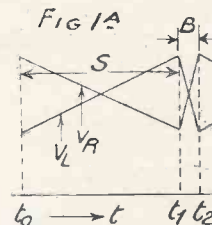

FIG. 1.

New time base arrangement
Patent 490529.



separated by dark lines—actually the shadows thrown by the grid. In the scanning operation, the dark lines disappear, so far as the received picture is concerned, though they produce a series of "control" currents, which are used to cancel out the false brilliance due to "tilt." The grid is preferably made to vibrate to and fro, so that the dark lines thrown on

Fig. 1A shows the relative changes of voltage on the deflecting plates. As the condenser C charges up, the potential on the left-hand plate P gradually rises to approximately that of the positive terminal of the H.T. supply. Similarly, the voltage on the right-hand plate P₁ falls towards zero or earth voltage, both crossing an intermediate value to give the

The information and illustrations on this page are given with permission of the Controller of H.M. Stationery Office.

push-pull effect. This represents the scanning pulses. As the condenser discharges, the original voltages are restored to give the rapid fly-back stroke B.—*Telefunken Ges für drahtlose Telegraphie m.b.h.*

Cathode-ray Tubes

(Patent No. 491,050.)

The whole of the "lens" or focusing system of a cathode-ray tube is made from a single piece of insulating material, suitably shaped into one rigid structure. The parts which are to serve as electrodes in the path of the stream are then metallised; either by spraying or by a silver-plating process.

This avoids the necessity for separately mounting the various electrodes, which, on account of the small tolerances permissible, calls for highly-skilled labour and accounts to a large extent for the initial cost of the tube.—*E. Michaelis.*

Preventing Loss of Definition

(Patent No. 491,413.)

The figure shows a cathode-ray tube of the Iconoscope type, where the picture to be televised is projected from a lens L on to a "mosaic-cell" screen S, which is scanned by an electron stream from the gun G of the tube, so that signal voltages are developed across a resistance R.

It is found, rather contrary to what might be expected, that when a brilliant picture is being transmitted there is sometimes a noticeable falling-off both in definition and tone-contrast. The explanation is that with a high value of illumination there is a tendency for some of the light to be reflected from the metallic coating of the electrode system on to the glass walls of the tube, and from there back on to the sensitive surface of the screen. Since this reflected light is naturally diffused, it adds an out-of-focus component to the currents produced by the original picture, and so tends to blur the details of the latter.

To prevent this, the mica sheet which carries the sensitive "cells" forming the mosaic screen S is covered with a layer of graphite or carbon, which blocks out any light reflected from the sides of the tube and so preserves the original definition of the picture.—*Marconi's Wireless Telegraph Co., Ltd.*

Fluorescent Screens

(Patent No. 491,748.)

Instead of applying a fixed coating of fluorescent material to the glass

end of a cathode-ray tube, the screen is formed by pouring a loose mass of finely-powdered material on the bottom of the bulb and then forming it into a level surface by shaking or tapping the tube.

As against the disadvantage of having to operate the tube in an inverted position, so that the picture must be viewed through a reflecting mirror, the arrangement possesses certain definite merits.

For instance a much thicker layer of fluorescent material can be used, and no "binder" is necessary. A loose layer 1 millimetre thick will produce several times the amount of light that can be obtained from the usual thin layer of adherent material. Again, if by any chance a part of the material is burnt by the scanning stream, a fresh surface can be formed by tapping or shaking fresh powder

(Patent No. 490,203.)

Transmission system which permits the insertion of advertising or other "insets," and the production of "composite" or built-up pictures.—*Marconi's Wireless Telegraph Co., Ltd.*

(Patent No. 490,391.)

Means for preventing the "blurring" of rapidly moving objects in a television transmitter.—*Fernseh Akt.*

(Patent No. 490,396.)

Method of adjusting the amplitude of the picture signals independently of the synchronising impulses.—*E. L. C. White and O. L. Ratsey.*

(Patent No. 491,011.)

Producing a photo-electric mosaic from a coating of caesium laid on a sheet of insulating material and cut through in criss-cross fashion.—*A. M. Low.*

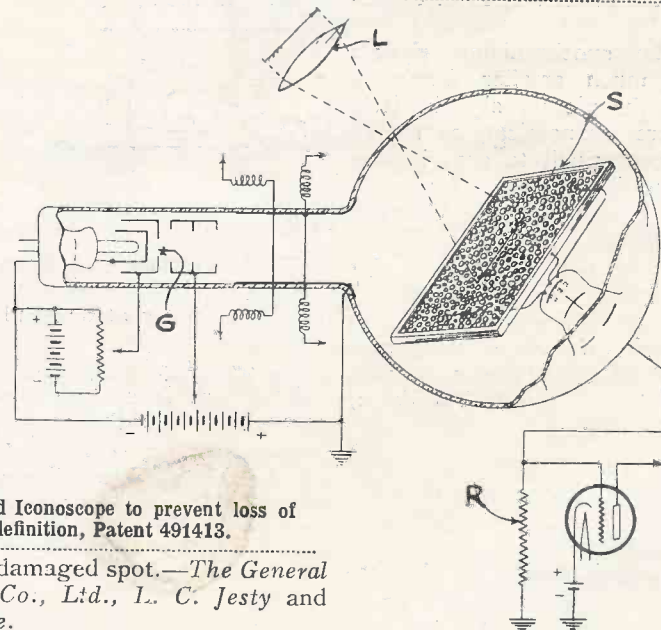

Modified Iconoscope to prevent loss of definition, Patent 491413.

over the damaged spot.—*The General Electric Co., Ltd., L. C. Jesty and J. Sharpe.*

Summary of Other Television Patents

(Patent No. 489,666.)

Generating flat-topped synchronising impulses for "framing" in television.—*Marconi's Wireless Telegraph Co., Ltd.*

(Patent No. 489,715.)

Valve circuit for "mixing" the synchronising impulses and picture signals in a television transmitter.—*Baird Television, Ltd., and A. J. Brown.*

(Patent No. 489,717.)

Method of "fading-out" part of one televised picture and replacing it by an "inset" from another.—*Baird Television, Ltd., V. A. Jones, and T. C. Nuttall.*

(Patent No. 491,425.)

Iconoscope tube in which a number of electron multipliers are symmetrically mounted about the mosaic screen and used to amplify the output current.—*Marconi's Wireless Telegraph Co., Ltd.*

(Patent No. 491,611.)

Method of driving the piezo-electric crystal used in a superionic type of light-modulator.—*Scophony, Ltd., J. Sieger and S. H. M. Doddington.*

(Patent No. 491,873.)

Time-base circuit in which faulty synchronisation is avoided when receiving television signals with interlaced scanning.—*The British Thomson-Houston Co., Ltd., and D. S. Watson.*

The information and illustrations on this page are given with permission of the Controller of H.M. Stationery Office.